

MANITOWOC CRANES, INC.

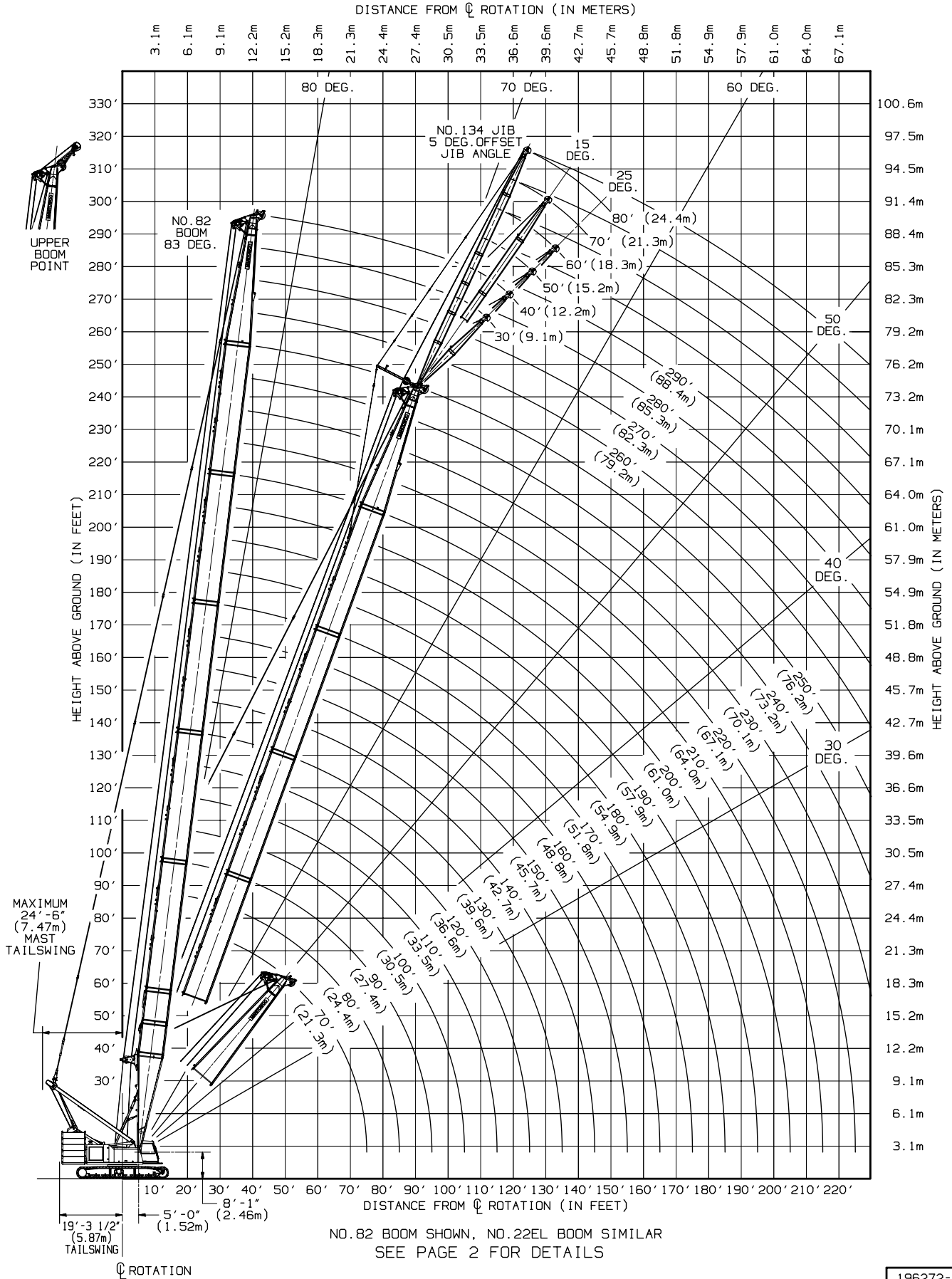

RANGE DIAGRAM - 999 SERIES 1, SERIES 2, & SERIES 3 (#82 BOOM OR #22EL BOOM & #134 JIB)

MANITOWOC CRANES, INC.

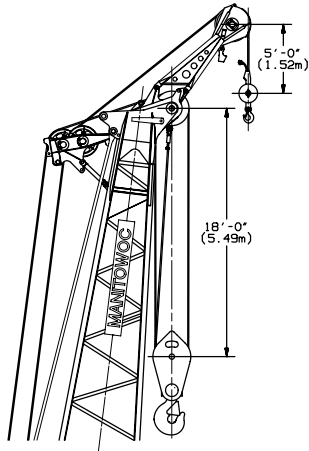

220 US TON (200 METRIC TON)
BLOCK TO BOOM POINT MINIMUM DISTANCE
NO. 82 BOOM OR NO. 22EL BOOM
16 PARTS OF LINE

MINIMUM DISTANCE MEASUREMENTS FROM MANITOWOC
LOAD BLOCK TO BOOM POINT SHOWN ABOVE
BASED ON 83 DEGREE BOOM ANGLE AND 2 1/2 DEGREE
FLEET ANGLE OR PHYSICAL LIMITATIONS.

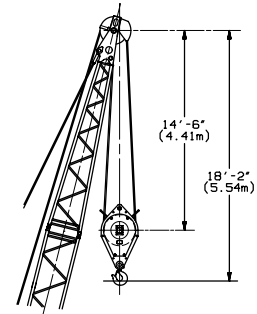
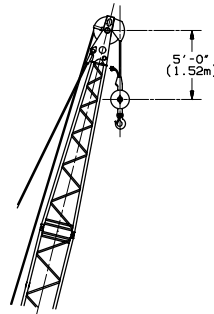
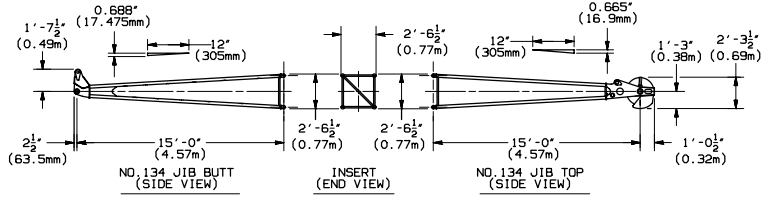
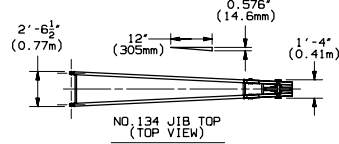
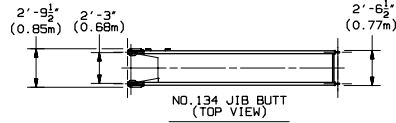

15 US TON (14 METRIC TON)
SWIVEL HOOK & WEIGHT BALL
TO JIB POINT MINIMUM DISTANCE
NO. 134 JIB - SINGLE PART LINE

30 US TON (27 METRIC TON)
BLOCK TO JIB POINT
MINIMUM DISTANCE
NO. 134 JIB - 2 PARTS OF LINE

MINIMUM DISTANCE MEASUREMENTS FROM MANITOWOC LOAD BLOCK
TO JIB POINT BASED ON 76 DEGREE JIB ANGLE AND 2 1/2 DEGREE
FLEET ANGLE OR PHYSICAL LIMITATIONS.

- NOTE 1: THIS DRAWING IS INTENDED ONLY AS A GUIDE TO ASSIST IN JOB PLANNING.
- NOTE 2: FOR PLANNING A LIFT, THIS DRAWING IS TO BE USED IN CONJUNCTION WITH APPROPRIATE CAPACITY CHARTS, RANGE CHART, WIRE ROPE SPECIFICATIONS, RIGGING DRAWING, AND OUTLINE DIMENSIONS.
- NOTE 3: FOR PLANNING LIFTS WHERE CLEARANCES ARE LIMITED AND ACCURACY IS DESIRED, A DETAILED LAYOUT SHOULD BE PREPARED.
- NOTE 4: WHEN EQUIPPED WITH BLOCK-UP LIMIT CONTROL, LOAD BLOCK TO BOOM POINT/JIB POINT MINIMUM DISTANCE MAY BE MORE THAN INDICATED. SEE OPERATOR'S MANUAL FOR "BLOCK-UP LIMIT CONTROL".
- NOTE 5: MAXIMUM BOOM ANGLE 83 DEGREES FOR NO. 82 BOOM OR NO. 22EL BOOM. MAXIMUM BOOM ANGLE 81 DEGREES FOR NO. 82 BOOM OR NO. 22EL BOOM AND NO. 134 JIB.
- NOTE 6: MAXIMUM BOOM AND BOOM AND JIB LENGTHS SHOWN ON SHEET 1 ARE FOR MACHINE EQUIPPED WITH SERIES 2 COUNTERWEIGHT. IN ALL CASES, REFER TO CRANE BOOM RIGGING OR CAPACITY CHART FOR MAXIMUM LENGTHS.

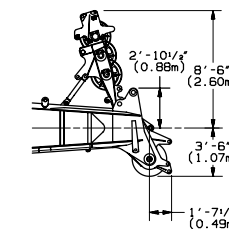
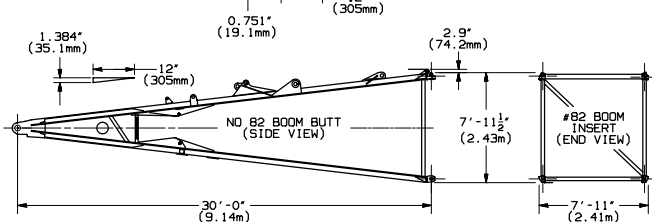
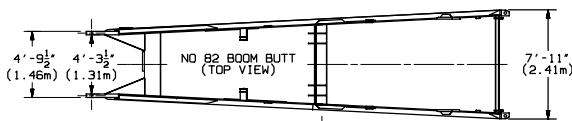
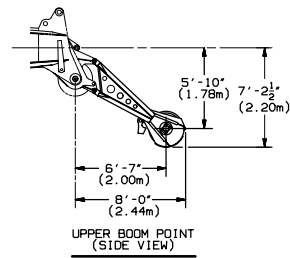
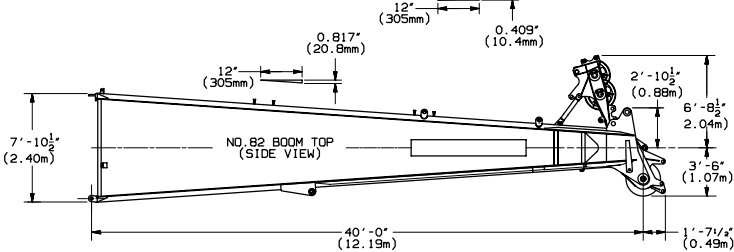
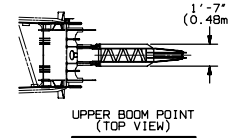
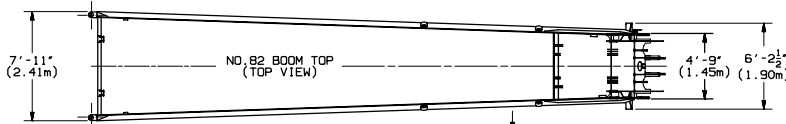

NO. 82 BOOM SHOWN, NO. 22EL BOOM SIMILAR