

GR-1600XL

160 Ton Capacity (145 Metric Tons)

HYDRAULIC ROUGH TERRAIN CRANE

DIMENSIONS

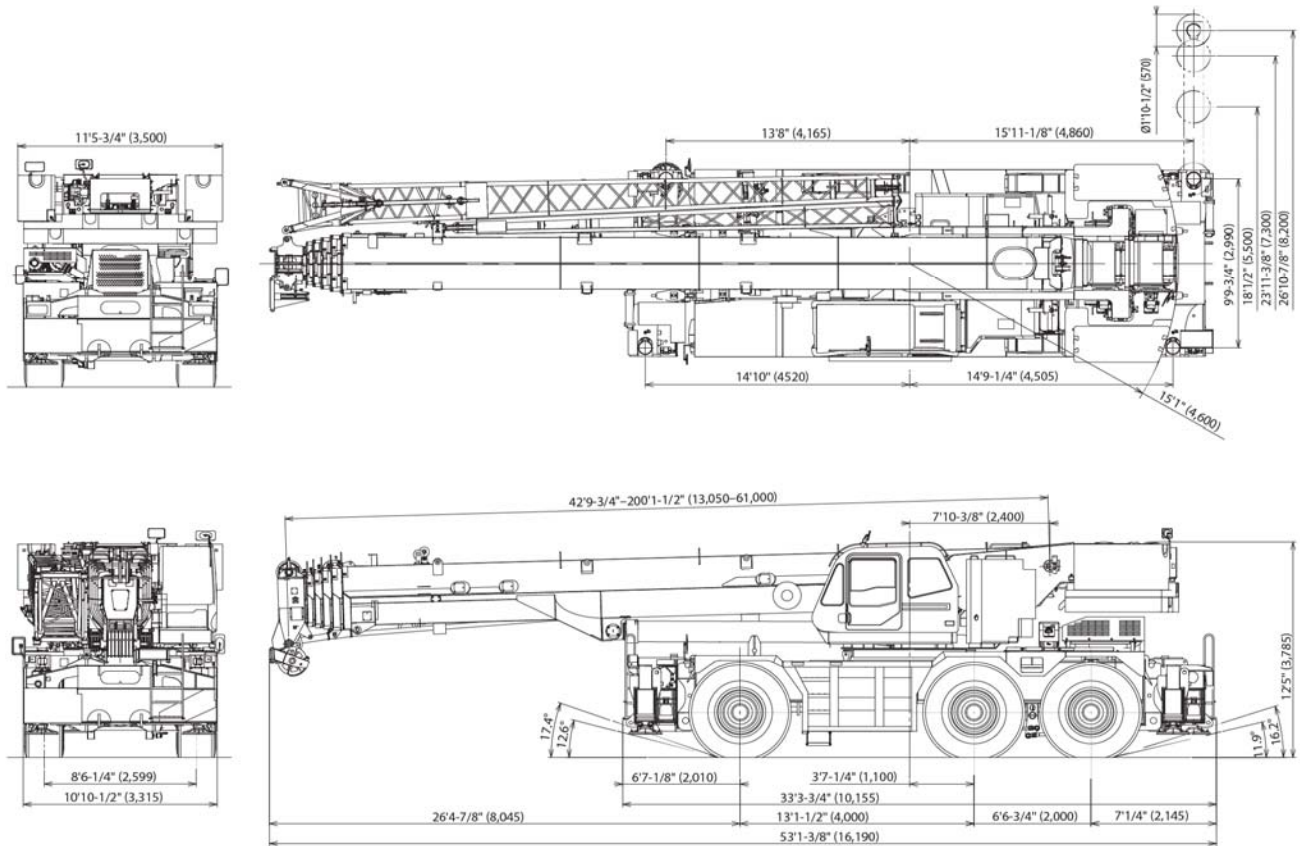

Note : Dimension is with boom angle at -1.5 degree.

GENERAL DIMENSIONS (26.5 R25 Tires)

	Feet	Meters
Turning radius		
6 wheel steer	32' 6"	9.9
2 wheel steer	48' 11"	14.9
Tail swing of counterweight	15' 1"	4.6

CRANE SPECIFICATIONS

BOOM

Six section boom, single cylinder telescoping with pinning system, 42.8' - 200.1' (13.1m - 61.0m), of round box construction with seven sheaves, 15-3/4" (0.400m) root diameter, at boom head. Two easily removable wire rope guards, rope dead end provided on both sides of boom head. Boom telescope sections are supported by wear pads both vertically and horizontally. Extension speed 157.3' in 450 seconds.

BOOM ELEVATION - By a double acting hydraulic cylinder with holding valve. Elevation minus 1.5° - 81.5°, combination controls for hand or foot operation. Boom angle indicator. Automatic speed reduction and soft stop function. Boom raising speed 20° to 60° in 28 seconds.

JIB - Two stage bi-fold lattice type with Ø, 20° or 40° offset (tilt type). Single sheave, 17-5/16" (0.440m) root diameter, at the head of both jib sections. Stored alongside base boom section. Jib length is 33.8' (10.3m) or 59.1' (18.0m). Assistant cylinders for mounting and stowing, controlled at right side of superstructure. Self stowing jib mounting pins.

INSERT JIB (*Optional)

Two lattice insert sections (23.0' each) to extend to 105.0'.

HEAVY DUTY JIB (*Optional)

Two sheaves, heavy lifting jib with 20° or 40° offset (tilt type). Jib length is 11.8' (3.6m).

AUXILIARY LIFTING SHEAVE (SINGLE TOP)

Single sheave, 17-5/16" (0.440m) root diameter. Mounted to main boom head for single line work (storable).

ANTI-TWO BLOCK - Pendant type over-winding cut out device with audio-visual (FAILURE lamp/BUZZER) warning system.

SLEWING

Hydraulic axial piston motor through planetary slewing speed reducer. Continuous 360° full circle slewing on ball bearing turn table at 1.3min⁻¹ {rpm}. Equipped with manually locked/released slewing brake. A 360° positive slewing lock manually engaged in cab. Twin slewing system: Free slewing or lock slewing controlled by selector switch on front console.

MAIN HOIST - Variable speed type with grooved drum driven by hydraulic axial piston motor through speed reducer. Power load lowering and raising. Equipped with automatic brake (neutral brake) and counterbalance valve. Controlled independently of auxiliary hoist. Equipped with cable follower and drum rotation indicator.

DRUM - Grooved 15" (0.382m) root diameter x 29-1/4" (0.742m) wide. Wire rope: 1050' of 3/4" diameter rope (320m of 19mm). Drum capacity: 1293' (394m) 7 layers. Maximum single line pull (available): 21,800 lbs (9,900kg). Maximum line speed: 505FPM (154m/min) at the 6th layer.

AUXILIARY HOIST - Variable speed type with grooved drum driven by hydraulic axial piston motor through speed reducer. Power load lowering and raising. Equipped with automatic brake (neutral brake) and counterbalance valve. Controlled independently of main hoist. Equipped with cable follower and drum rotation indicator.

DRUM - Grooved 15" (0.382m) root diameter x 29-1/4" (0.742m) wide. Wire rope: 738' of 3/4" diameter rope (225m of 19mm). Drum capacity: 1293' (394m) 7 layers. Maximum single line pull (available): 21,800 lbs (9,900kg). Maximum line speed: 476FPM (145m/min) at the 5th layer.

WIRE ROPE - Non-rotating 3/4" (19mm) 7x35 class. Breaking Strength 79,400 lbs (36,000 kg)

HOOK BLOCKS

110 ton (100 metric ton) - 7 sheaves with swivel hook block
7.9 ton (7.2 metric ton) - Weighted hook ball with swivel and safety latch.

COUNTERWEIGHT

Self-removable counterweight (40,100 + 24,500 = 64,600 lbs)

HYDRAULIC SYSTEM

PUMPS - Two variable piston pumps for crane functions. Tandem gear pump for steering, slewing and optional equipment. Powered by carrier engine. Pump disconnect for crane is engaged/ disengaged by rotary switch from operator's cab.

CONTROL VALVES - Multiple valves actuated by pilot pressure with integral pressure relief valves.

RESERVOIR - 202 gallon (763 lit.) capacity. External sight level gauge.

FILTRATION - BETA10=10 return filter, full flow with bypass protection, located inside of hydraulic reservoir. Accessible for easy replacement.

OIL COOLER - Air cooled fan type.

CAB AND CONTROLS

Both crane and drive operations can be performed from one cab mounted on rotating superstructure.

Left side, 1 man type, tilting cab, steel construction with sliding door access and safety glass windows opening at side. Door window is powered control. Windshield glass window and roof glass window are shatter-resistant. Tilt-telescoping steering wheel. Adjustable control lever stands for slewing, boom elevating, boom telescoping, auxiliary hoist and main hoist. Control lever stands can change neutral positions and tilt for easy access to cab. 3 way adjustable operator's seat with high back, headrest and armrest. Engine throttle knob. Foot operated controls: boom elevating, boom telescoping, service brake and engine throttle. Hot water cab heater and air conditioning.

Dash-mounted engine start/stop, monitor lamps, cigarette lighter, drive selector switch, parking brake switch, steering mode select switch, power window switch, pump engaged/disengaged switch, slewing brake switch, telescoping/auxiliary hoist select switch, outrigger controls, free slewing / lock slewing selector switch, eco mode switch, high speed hoist (main/aux) switch and ashtray.

Instruments - Torque converter oil temperature, engine water temperature, air pressure, fuel, speedometer, tachometer, hour meter and odometer / tripmeter. Hydraulic oil pressure is monitored and displayed on the AML-C display panel.

Tadano electronic LOAD MOMENT INDICATOR system (AML-C) including:

- Control lever lockout function
- Boom position indicator
- Outrigger state indicator
- Boom angle / boom length / jib offset angle / jib length / load radius / rated lifting capacities / actual loads read out
- Ratio of actual load moment to rated load moment indication
- Automatic Speed Reduction and Slow Stop function on boom elevation and slewing
- Working condition register switch
- Load radius / boom angle / tip height / slewing range preset function
- External warning lamp
- Tare function
- Fuel consumption monitor

- Main hoist / auxiliary hoist select
- Drum rotation indicator (audible and visible type) main and auxiliary hoist

TADANO AML-C monitors outrigger extended length and automatically programs the corresponding "RATED LIFTING CAPACITIES" table

Operator's right hand console includes transmission gear selector and sight level bubble. Upper console includes working light switch, roof washer and wiper switch emergency outrigger set up key switch, jib equipped/removed select switch, eco mode switch, high speed hoist (main / aux) switch, Cab tilt switch, and air conditioning control switch. Slewing lock lever.

NOTE: Each crane motion speed is based on unloaded conditions.

CARRIER SPECIFICATIONS

TYPE - Rear engine, left hand steering, driving axle 2-way selected type by manual switch, 6x2 1st axle drive, 6x4 1st and 3rd axle drive.

FRAME - High tensile steel, all welded mono-box construction.

TRANSMISSION - Electronically controlled full automatic transmission. Torque converter driving full powershift with driving axle selector. 5 forward and 2 reverse speeds, constant mesh.

- 2 speeds - high range - 2 wheel drive; 4 wheel drive
- 3 speeds - low range - 4 wheel drive

TRAVEL SPEED - 9.3 mph (15 km/h) *with counterweight
2.4 mph (4 km/h) *without counterweight

GRADEABILITY (tanθ)

44% *with counterweight 64,600 lbs (29.3 t)

52% *with counterweight 40,100 lbs (18.2 t)

Machine should be operated within the limit of engine crankcase design (30° - Cummins QSB6.7)

AXLE

1st axle - Full floating type, steering and driving axle with planetary reduction.

2nd axle -Steering axle

3rd axle - Full floating type, steering and driving axle with planetary reduction.

STEERING- Hydraulic power steering controlled by steering wheel. Four steering modes available: 2 wheel front, 4 wheel rear, 6 wheel coordinated and 6 wheel crab
Emergency steering device

ENGINE

Model	Cummins QSB6.7 [Tier4]
Type	Direct injection diesel
No. of cylinders	6
Combustion	4 cycle, turbo charged and after cooled
BoreXStroke, in.(mm)	4.212 x 4.882 (107 x 124)
Displacement, cu. in (liters)	409 (6.7)
Air inlet heater	24 volt preheat
Air cleaner	Dry type, replaceable element
Oil filter	Full flow with replaceable element
Fuel filter	Full flow with replaceable element
Fuel tank, gal.(liters)	79.2 (300), right side of carrier
Cooling	Liquid pressurized, recirculating by-pass

SUSPENSION

1st axle - Rigid mounted to frame.

2nd and 3rd axles - "Hydro-Pneumatic suspension cylinders" with leveling adjustment and oscillation.

BRAKE SYSTEMS - Service: Air over hydraulic disc brakes on all 6 wheels. Parking/Emergency: Spring applied-air released brake acting on input shaft of 1st and 3rd axles. Auxiliary: Electro-pneumatic operated exhaust brake.

TIRES - 26.5 R25

OUTRIGGERS - Four hydraulic, beam and jack outriggers. Vertical jack cylinders equipped with integral holding valve. Each outrigger beam and jack is controlled independently from cab. Beams extend to 26'10-7/8" (8.2 m) center-line and retract to within 10' 10-1/2" (3.315 m) overall width with floats. Outrigger jack floats are attached thus eliminating the need of manually attaching and detaching them. Controls and sight bubble located in superstructure cab. Four outrigger extension lengths are provided with corresponding "RATED LIFTING CAPACITIES" for crane duty in confined areas.

Self-removable outrigger boxes for ease of transportation.

Min. Extension	9' 9-3/4" (2.99m) center to center
Mid. Extension	18' 1/2" (5.50m) center to center
Mid. Extension	23' 11-3/8" (7.30m) center to center
Max. Extension	26' 10-7/8" (8.20m) center to center
Float size(Diameter)	1' 10-1/2" (0.57m)

Radiator	Fin and tube core, thermostat controlled
Fan, in.(mm)	Suction type, 9-blade, 28 (711) dia.
Starting	24 volt
Charging	24 volt system, negative ground
Battery	2-120 amp. Hour
Compressor, air, CFM(l /min)	17.0 CFM (481) at 2,400rpm
Horsepower (kW)	Gross 270 (201) at 2,000rpm
Torque, Max. ft-lb (Nm)	730 (990) at 1,500rpm
Capacity, gal.(liters)	
Cooling water	7.6 (29)
Lubrication	4.0 (15)
Fuel	79.2 (300)
DEF	10.0 (38)

STANDARD EQUIPMENT

- Six section boom, single cylinder telescoping with pinning system
42.8' - 200.1' (13.1m - 61.0m)
- 33.8' or 59.1' (10.3m or 18.0m) bi-fold lattice jib (tilt type)
with 0°, 20° or 40° pinned offsets and self stowing pins.
- Quick reeving type bi-fold jib
- Auxiliary lifting sheave (single top) storable
- Variable speed main hoist with grooved drum, cable follower
and 1050' of 3/4" cable.
- Variable speed auxiliary hoist with grooved drum, cable follower
and 738' of 3/4" cable.
- Drum rotation indicator (audible, visible and thumper type) main
and auxiliary hoist
- Anti-Two block device (overwind cutout) and lower limit (3rd wrap)
- Boom angle indicator
- Tadano electronic load moment indicator system (AML-C)
- Outrigger extension length detector
- Tadano twin slewing system and 360° positive slewing lock
- Tilting cab
- Self centering finger control levers with pilot control
- Control pedals for boom elevating and boom telescoping
- 3 way adjustable cloth seat with armrests, high back
and seat belt
- Tilt-telescoping steering wheel
- Tinted safety glass and sun visor
- Front windshield wiper and washer
- Roof window wiper and washer
- Power window (cab door)
- Rear view mirrors (right and left side)
- Mirror for main and auxiliary hoists
- Cigarette lighter and ashtray
- Cab floor mat
- Pump disconnect in operator's cab
- Hydraulic oil cooler
- Air conditioner (hot water heater and cooler)
- Positive control
- Work lights
- Independently controlled outriggers
- Four outrigger extension positions
- Cummins QSB6.7 turbo charged after cooled engine
(270HP) with exhaust brake
- Electronic controlled automatic transmission driven
by torque converter
- 6 X 4 X 6 drive/steer
- Automatic 2nd and 3rd axle oscillation lock out system
- 26.5 R25 tires
- Disc brakes
- Fenders
- Air dryer
- Water separator with filter (high filtration)
- Engine over-run alarm
- Back-up alarm
- Low oil pressure/high water temp. warning device (visual)
- 2nd and 3rd steer centering light
- Air cleaner dust indicator
- Tool storage compartment
- Tire inflation kit
- 24 volt electric system
- 7.9 ton (7.2 metric ton) hook ball with swivel
- 110 ton (100 metric ton) - 7 sheaves with swivel hook block
and safety latch for 3/4" wire rope
- Weighted hook storage compartment
- Hook block tie down (front bumper)
- Towing hooks-Front and rear
- Lifting eyes
- Halogen head lamp
- Telematics (machine data logging and monitoring system)
with HELLO-NET via internet
- Fuel consumption monitor
- Eco mode system
- Self-removable counterweight (40,100 + 24,500 = 64,600 lbs)
- Self-removable outrigger boxes
- Emergency steering assist
- Anemometer
- Aircraft warning light

OPTIONAL EQUIPMENT

- 33.8' or 59.1' (10.3m or 18.0m) bi-fold lattice jib (tilt type)
with 5° - 40° hydraulic offset.
* Replaces standard fly jib if purchased as optional.
- 11.8' (3.6 m) heavy duty jib
- 2 x 23.0' (7.0 m) lattice inserts
- 50 ton (45 metric ton) - 3 sheaves with swivel hook block
and safety latch for 3/4" wire rope
- Boom removal assist system

HOISTING PERFORMANCE

LINE SPEEDS AND PULLS

Layer	Main or auxiliary hoist - 15" (0.382m) drum					
	Line speeds ¹				Line pulls - Available ²	
	Low		High		Low	
	F.P.M.	m/min	F.P.M.	m/min	Lbs.	kgf
1st	253	77	354	108	21,800	9,900
2nd	276	84	384	117	19,900	9,010
3rd	299	91	413	126	18,200	8,270
4th	318	97	446	136	16,800	7,640
5th	341	104	476	145	15,600	7,090
6th	361	110	505	154	14,600	6,620
7th ³	384	117	535	163	13,700	6,210

* Maximum permissible line pull may be affected by wire rope strength.
Maximum lifting capacity per line (Main & Aux.): 15,900lbs (7,200kg)

¹ Line speeds based only on hook block, not loaded.

² Developed by machinery with each layer of wire rope, but not based
on rope strength or other limitation in machinery or equipment.

³ Seventh layer of wire rope are not recommended
for hoisting operations.

DRUM WIRE ROPE CAPACITIES

Wire rope layer	Main and auxiliary drum grooved lagging			
	3/4" (19mm) wire rope			
	Rope per layer		Total wire rope	
	Feet	Meters	Feet	Meters
1	147.0	44.8	147.0	44.8
2	159.4	48.6	306.4	93.4
3	172.2	52.5	478.7	145.9
4	184.7	56.3	663.4	202.2
5	197.2	60.1	860.6	262.3
6	209.6	63.9	1070.2	326.2
7	222.1	67.7	1292.3	393.9

DRUM DIMENSIONS

	Inch	mm
Root diameter	15	382
Length	29-1/4	742
Flange diameter	26-5/8	677

GR-1600XL WORKING RANGE CHART

Manual offset jib
Counterweight 64,600 lbs

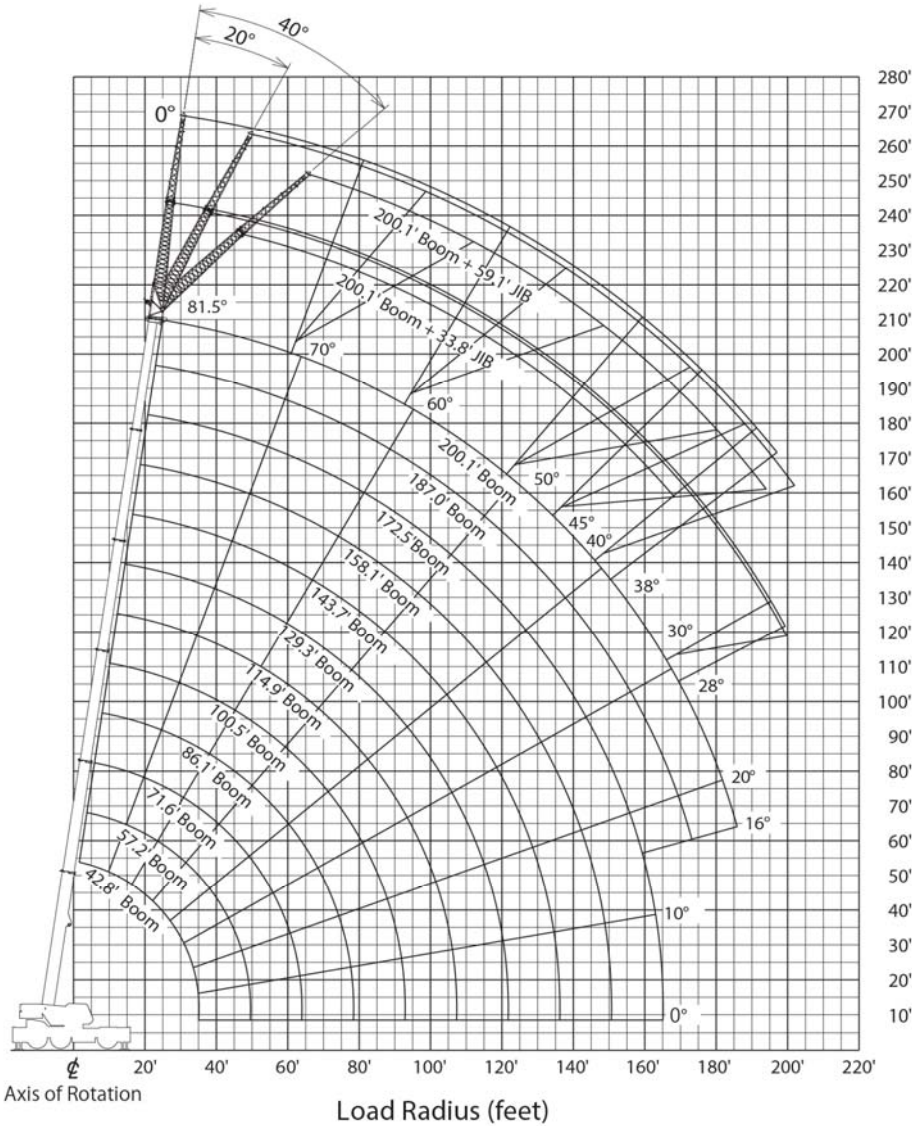

BOOM

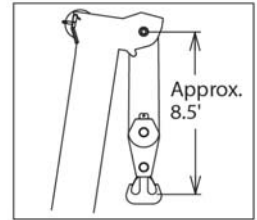

JIB

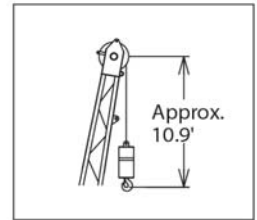

SINGLE TOP

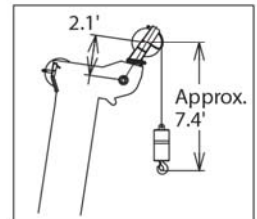

Lifting Height (feet)

NOTE: Boom and jib geometry shown are for unloaded condition and machine standing level on firm supporting surface.
 Boom deflection and subsequent radius and boom angle change must be accounted for when applying load to hook.

GR-1600XL WORKING RANGE CHART

Manual offset jib	*optional
23.0' insert jib	
Counterweight 64,600 lbs	

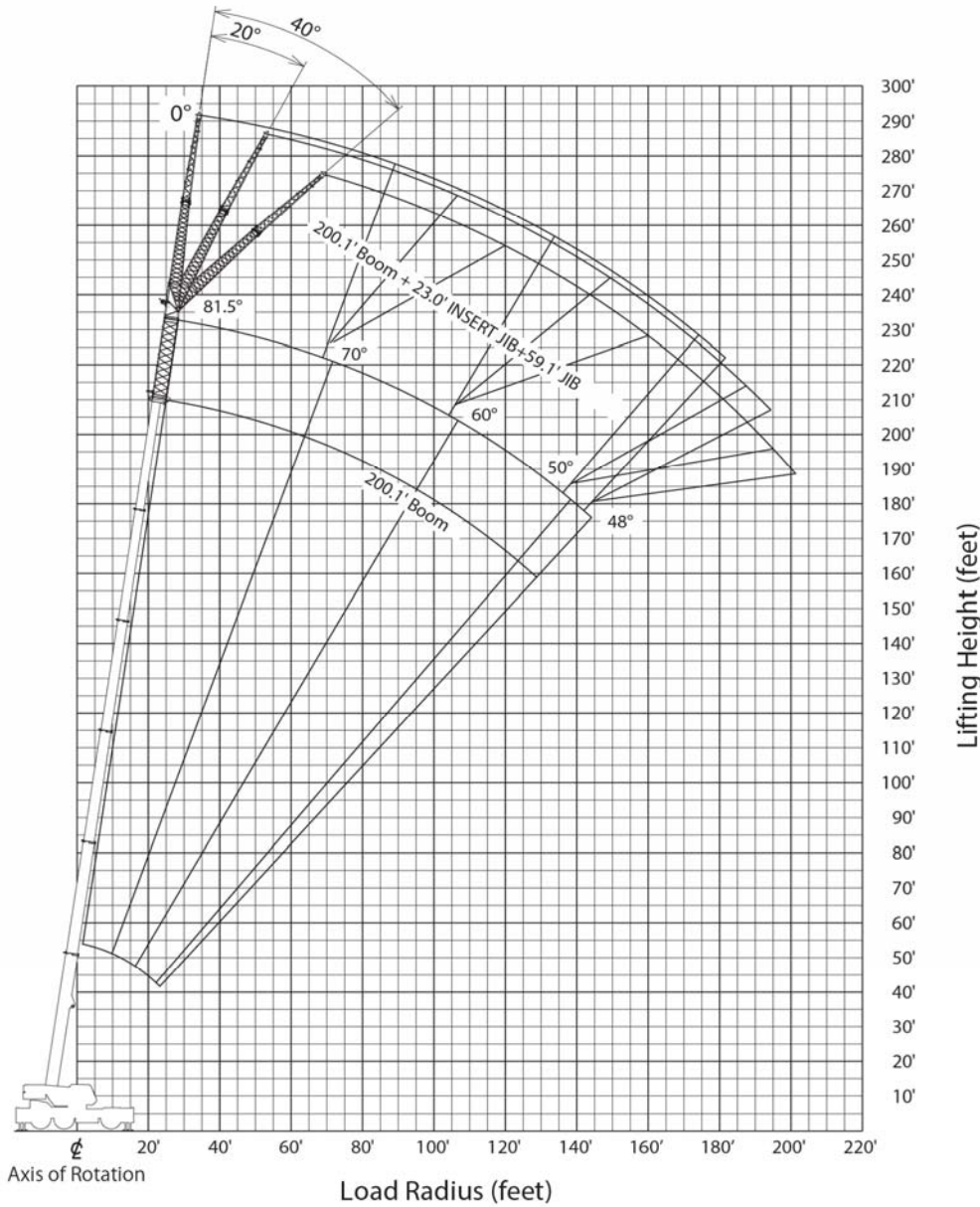

BOOM

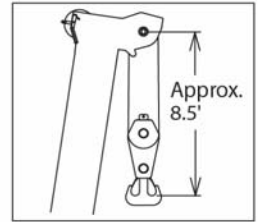

JIB

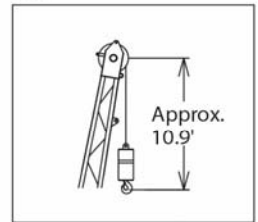

SINGLE TOP

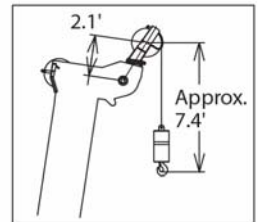

NOTE: Boom and jib geometry shown are for unloaded condition and machine standing level on firm supporting surface.
 Boom deflection and subsequent radius and boom angle change must be accounted for when applying load to hook.

GR-1600XL WORKING RANGE CHART

Manual offset jib	*optional
45.9' insert jib	
Counterweight 64,600 lbs	

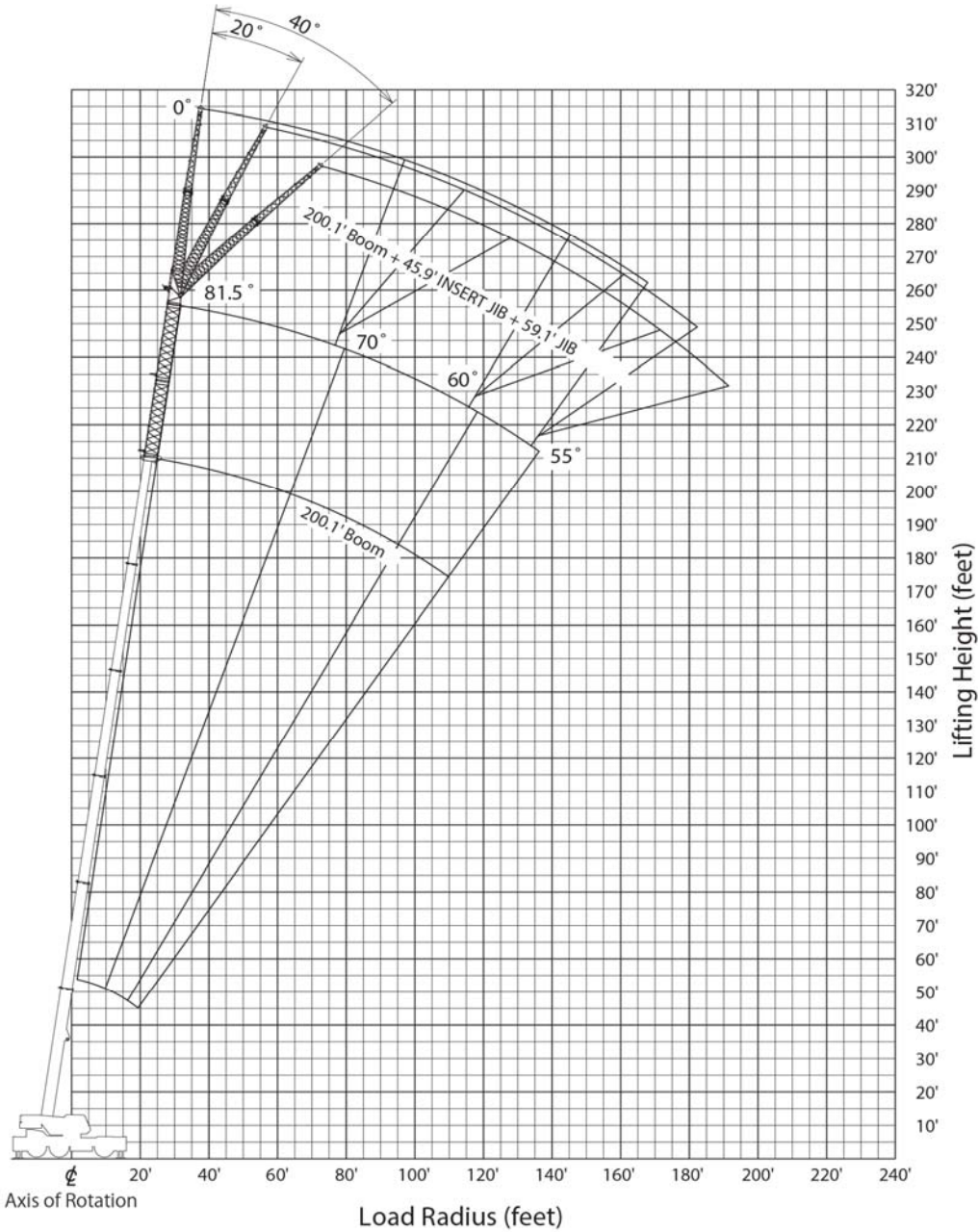

BOOM

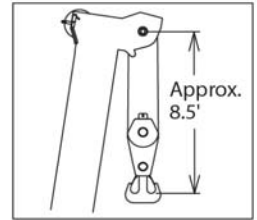

JIB

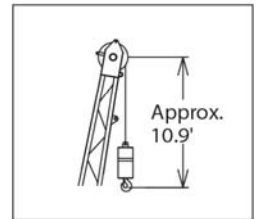

SINGLE TOP

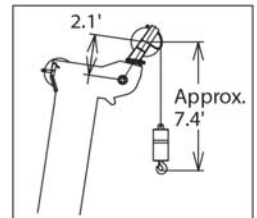

NOTE: Boom and jib geometry shown are for unloaded condition and machine standing level on firm supporting surface.
 Boom deflection and subsequent radius and boom angle change must be accounted for when applying load to hook.

GR-1600XL WORKING RANGE CHART

Hydraulic offset jib	*optional
Counterweight 64,600 lbs	

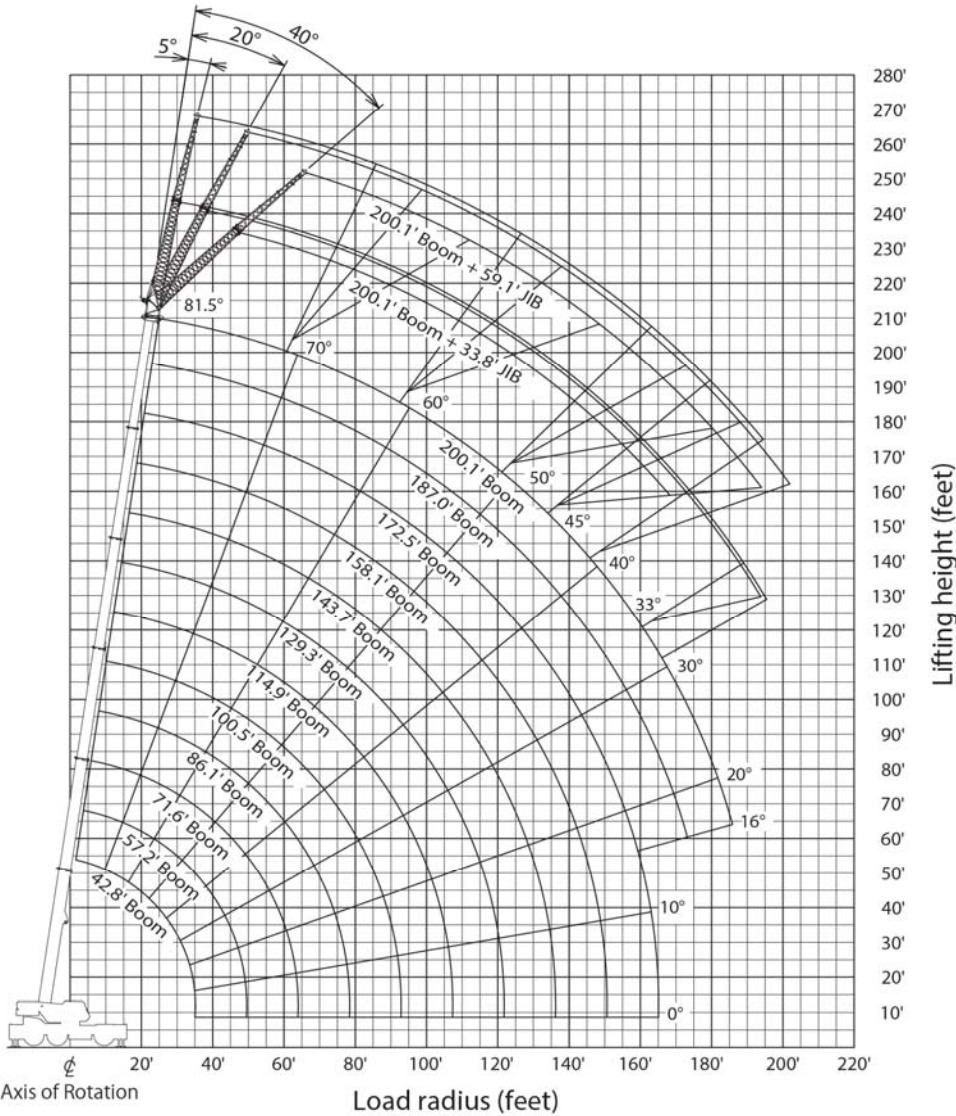

BOOM

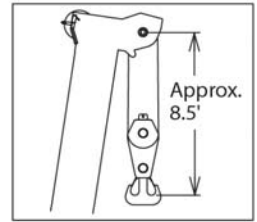

JIB

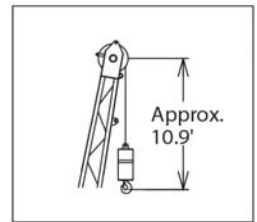

SINGLE TOP

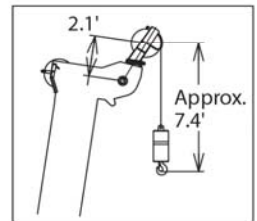

NOTE: Boom and jib geometry shown are for unloaded condition and machine standing level on firm supporting surface.
 Boom deflection and subsequent radius and boom angle change must be accounted for when applying load to hook.

GR-1600XL WORKING RANGE CHART

Hydraulic offset jib	*optional
23.0' insert jib	*optional
Counterweight 64,600 lbs	

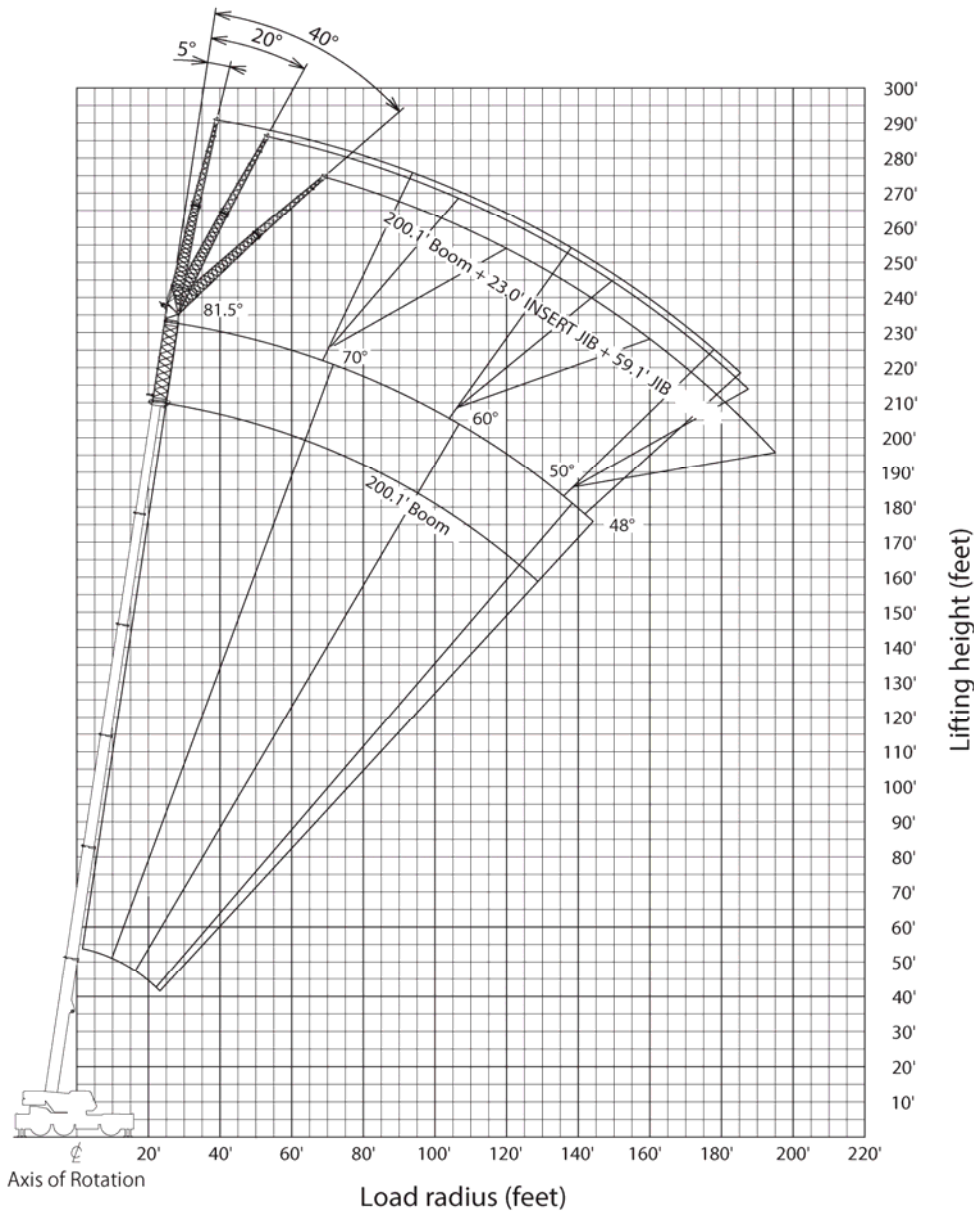

BOOM

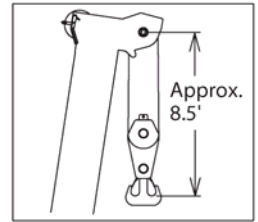

JIB

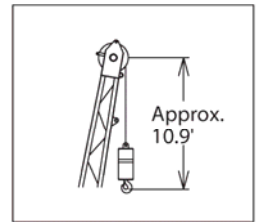

SINGLE TOP

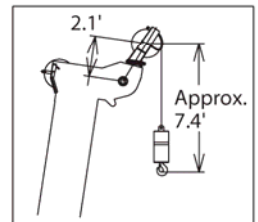

NOTE: Boom and jib geometry shown are for unloaded condition and machine standing level on firm supporting surface.
 Boom deflection and subsequent radius and boom angle change must be accounted for when applying load to hook.

GR-1600XL WORKING RANGE CHART

Hydraulic offset jib	*optional
45.9' insert jib	*optional
Counterweight 64,600 lbs	

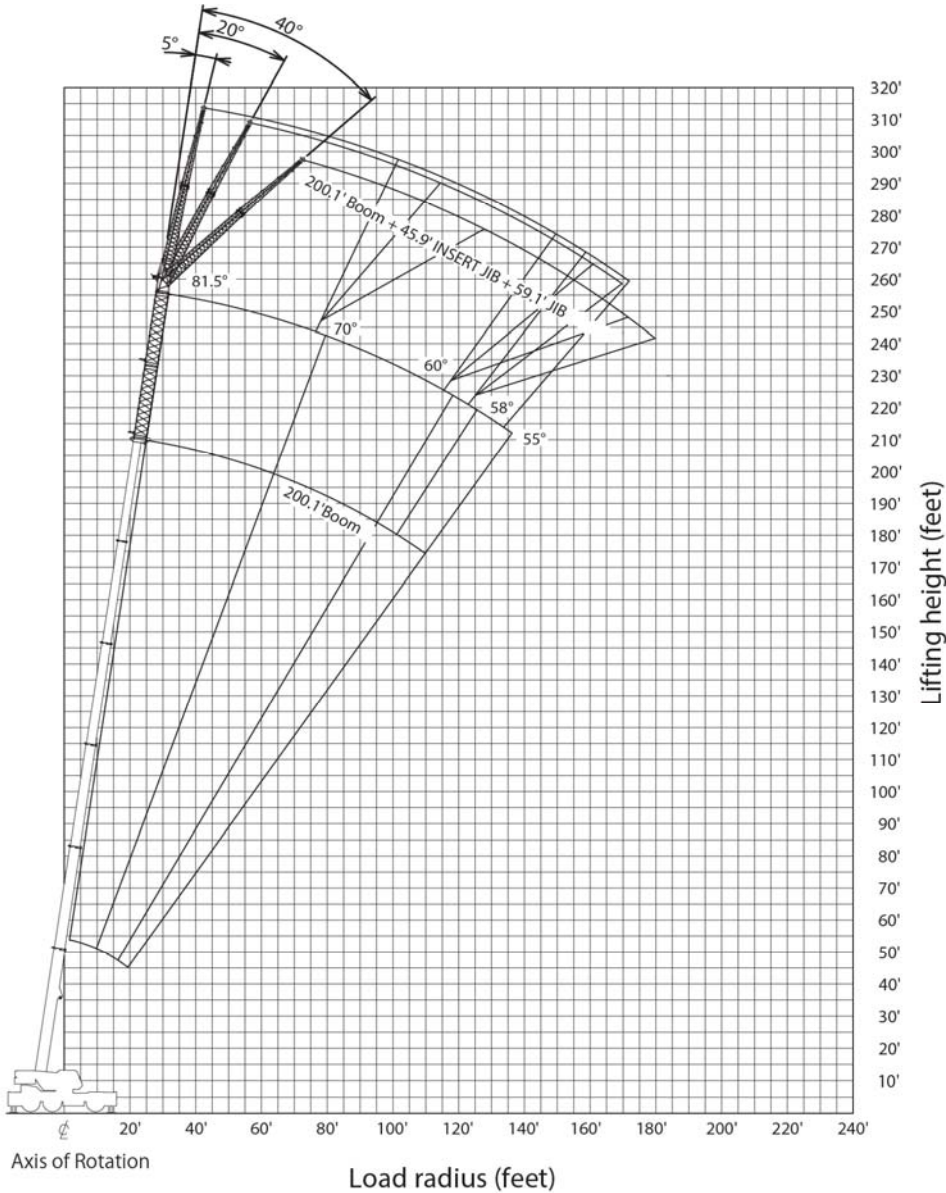

BOOM

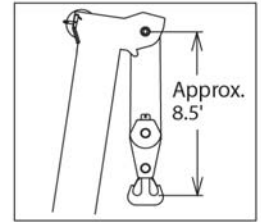

JIB

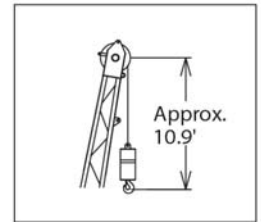

SINGLE TOP

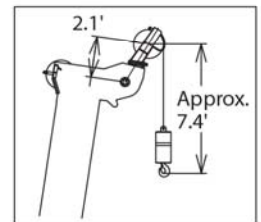

NOTE: Boom and jib geometry shown are for unloaded condition and machine standing level on firm supporting surface.
 Boom deflection and subsequent radius and boom angle change must be accounted for when applying load to hook.

GR-1600XL WORKING RANGE CHART

Heavy duty jib	*optional
Counterweight 64,600 lbs	

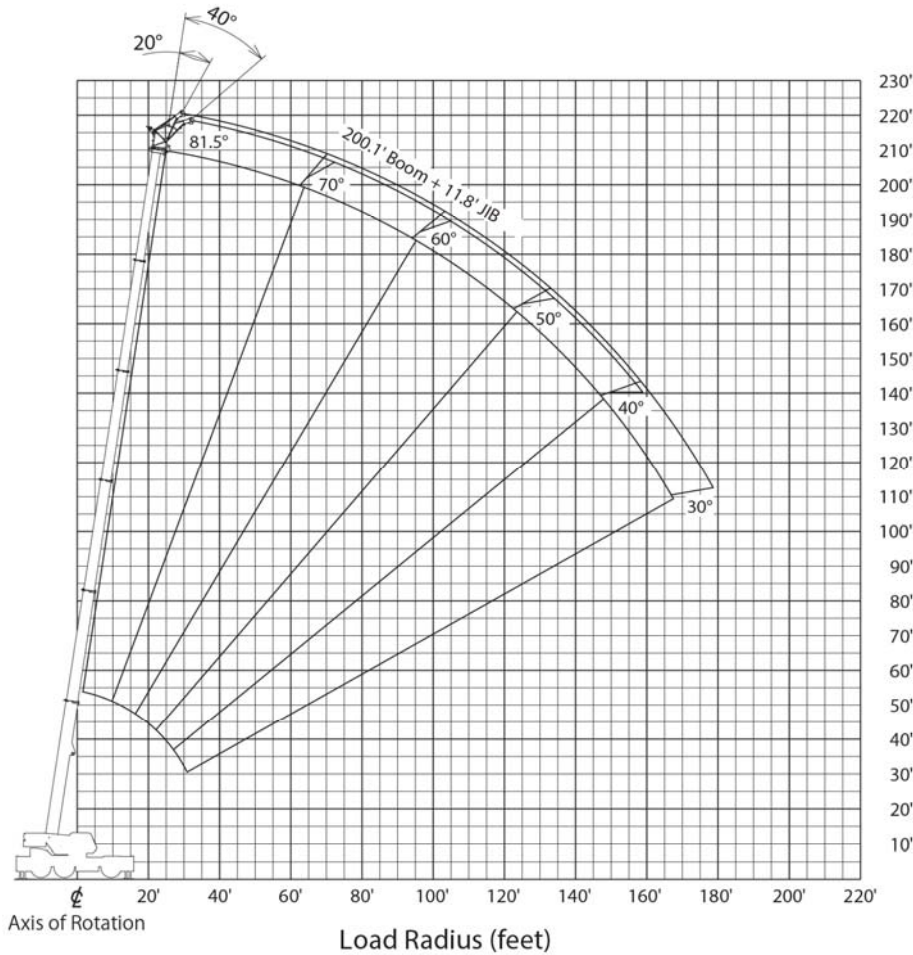

BOOM

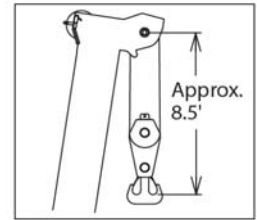

JIB

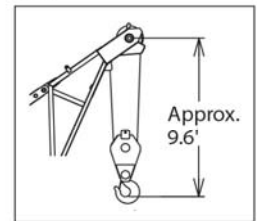

SINGLE TOP

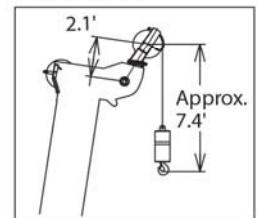

Lifting Height (feet)

NOTE: Boom and jib geometry shown are for unloaded condition and machine standing level on firm supporting surface.
 Boom deflection and subsequent radius and boom angle change must be accounted for when applying load to hook.

GR-1600XL RATED LIFTING CAPACITIES (IN POUNDS)

Boom

ON OUTRIGGERS FULLY EXTENDED 26' 10-7/8" (8.2m) SPREAD													
COUNTERWEIGHT 64,600 lbs (29,300 kg)													
360° ROTATION													
A \ B	42.8' (13.1m)	57.2' (17.4m)	71.6' (21.8m)	86.1' (26.2m)	100.5' (30.6m)	114.9' (35.0m)	129.3' (39.4m)	143.7' (43.8m)	158.1' (48.2m)	172.5' (52.6m)	187.0' (57.0m)	200.1' (61.0m)	
8'	** 320,000	200,000	174,200										
10'	241,800	200,000	174,200										
12'	218,000	200,000	174,200	145,500									
15'	187,100	182,800	174,200	145,500	111,800								
20'	148,300	148,800	145,500	138,700	106,300	84,700							
25'	121,500	122,400	122,800	120,800	106,300	77,600	66,400						
30'	101,000	102,500	102,700	102,100	97,700	77,600	61,100	52,700					
35'	48,700	85,100	85,300	84,700	86,200	74,700	54,900	48,900	41,700	33,100			
45'		64,200	62,400	64,200	63,300	63,500	46,700	43,000	37,700	33,100	26,500	22,900	
50'			54,700	56,200	55,600	57,100	43,900	39,200	35,500	32,000	26,500	22,900	
60'			45,400	44,300	46,100	45,200	38,800	33,500	31,100	28,400	26,000	22,900	
65'				41,000	41,400	40,300	36,600	31,100	28,900	26,900	24,700	22,700	
75'				32,600	33,500	32,600	33,100	27,100	24,900	24,000	22,300	20,500	
80'					30,200	29,500	30,400	25,400	23,600	22,500	21,200	19,600	
90'					23,600	26,000	24,700	22,500	21,200	19,800	19,200	17,600	
95'						23,800	22,500	21,400	20,100	18,700	18,100	16,500	
105'						18,500	18,700	19,000	18,100	17,000	16,300	14,800	
110'							17,200	17,900	16,800	16,300	15,700	14,100	
120'							12,800	15,200	14,100	15,000	13,900	12,600	
125'								14,100	13,400	13,700	12,800	11,900	
130'								13,000	12,800	12,600	11,700	11,200	
140'									11,500	10,800	9,700	9,700	
145'									10,600	9,900	9,000	9,000	
155'										8,400	7,500	7,500	
160'										7,900	6,800	6,600	
170'											5,500	5,500	
175'											4,900	4,900	
180'												4,400	
185'													3,700

** Over front and with additional lifting equipment

A :Boom length in feet

B :Load radius in feet

GR-1600XL RATED LIFTING CAPACITIES (IN POUNDS)

33.8' (10.3 m) Manual offset jib

ON OUTRIGGERS FULLY EXTENDED 26' 10-7/8" (8.2m) SPREAD COUNTERWEIGHT 64,600 lbs (29,300 kg) 360° ROTATION													
C	200.1' (61.0m) Boom + 33.8' (10.3m)						C	187.0' (57.0m) Boom + 33.8' (10.3m)					
	0° offset		20° offset		40° offset			0° offset		20° offset		40° offset	
	R	W	R	W	R	W		R	W	R	W	R	W
81.5	43.3'	12,100	56.8'	12,100	66.6'	11,500	81.5	38.7'	13,700	51.5'	13,700	61.0'	12,800
81	45.6'	12,100	59.4'	12,100	68.9'	11,200	81	41.0'	13,700	54.1'	13,700	63.0'	12,800
80	52.2'	12,100	64.6'	11,900	73.5'	10,800	80	45.9'	13,700	59.1'	13,700	67.3'	12,300
79	56.4'	12,100	69.9'	11,700	77.8'	10,600	79	50.9'	13,700	63.0'	13,200	71.2'	11,900
78	61.7'	12,100	73.8'	11,200	82.4'	10,400	78	55.5'	13,700	67.3'	12,800	75.1'	11,700
77	66.6'	12,100	78.1'	10,800	86.3'	9,900	77	60.4'	13,700	71.5'	12,300	79.1'	11,200
76	71.9'	12,100	83.0'	10,600	90.6'	9,700	76	65.0'	13,700	75.8'	12,100	83.0'	11,000
75	76.4'	11,700	87.3'	10,400	94.5'	9,500	75	69.2'	13,400	79.7'	11,700	86.9'	10,800
73	85.6'	11,000	95.8'	9,700	102.0'	9,000	73	77.4'	12,600	87.6'	11,000	94.2'	10,100
70	97.8'	9,900	108.0'	9,000	114.0'	8,400	70	89.2'	11,500	98.8'	10,100	105.0'	9,500
68	106.0'	9,500	115.0'	8,600	121.0'	7,900	68	96.5'	10,800	106.0'	9,700	112.0'	9,000
65	118.0'	8,800	127.0'	7,900	131.0'	7,500	65	107.0'	9,900	117.0'	9,000	121.0'	8,600
63	125.0'	8,200	134.0'	7,700	138.0'	7,300	63	115.0'	9,500	123.0'	8,600	128.0'	8,200
60	135.0'	7,500	143.0'	7,100	148.0'	6,800	60	125.0'	8,800	133.0'	8,200	137.0'	7,900
58	142.0'	7,100	150.0'	6,600	153.0'	6,400	58	132.0'	8,600	139.0'	7,900	142.0'	7,500
55	152.0'	6,600	159.0'	6,200	162.0'	6,000	55	141.0'	7,900	148.0'	7,500	151.0'	7,300
53	158.0'	6,200	165.0'	6,000	168.0'	5,700	53	146.0'	7,500	154.0'	7,300	156.0'	7,100
50	167.0'	5,500	173.0'	5,300	175.0'	5,100	50	155.0'	7,100	161.0'	6,600	163.0'	6,600
48	172.0'	5,100	178.0'	4,900	179.0'	4,900	48	160.0'	6,600	166.0'	6,400	168.0'	6,200
45	179.0'	4,600	185.0'	4,400	186.0'	4,400	45	167.0'	6,000	173.0'	5,700	174.0'	5,700
43	184.0'	4,200	190.0'	4,200			43	172.0'	5,700	177.0'	5,500		
40	191.0'	3,700	195.0'	3,500			40	178.0'	5,300	183.0'	4,900		
38	195.0'	3,300	199.0'	3,100			38	182.0'	4,600	186.0'	4,400		
35	200.0'	2,600	204.0'	2,400			35	188.0'	4,000	191.0'	3,700		
33	204.0'	2,400	207.0'	2,200			33	191.0'	3,700	194.0'	3,500		
30	209.0'	2,000	211.0'	1,800			30	196.0'	3,300	198.0'	3,100		
28	212.0'	1,800					28	199.0'	2,900	200.0'	2,900		
							25	203.0'	2,600	203.0'	2,400		
							23	205.0'	2,400				
							20	208.0'	2,200				

ON OUTRIGGERS FULLY EXTENDED 26' 10-7/8" (8.2m) SPREAD COUNTERWEIGHT 64,600 lbs (29,300 kg) 360° ROTATION													
C	172.5' (52.6m) Boom + 33.8' (10.3m)						C	114.9' (35.0m) Boom + 33.8' (10.3m)					
	0° offset		20° offset		40° offset			0° offset		20° offset		40° offset	
	R	W	R	W	R	W		R	W	R	W	R	W
81.5	33.8'	15,900	46.9'	15,900	56.8'	15,000	81.5			29.2'	23,400	37.1'	16,100
81	35.8'	15,900	48.9'	15,900	58.7'	14,800	81			30.5'	23,100	38.4'	15,900
80	40.4'	15,900	53.5'	15,900	62.7'	14,300	80			33.1'	22,500	41.0'	15,700
79	45.0'	15,900	57.7'	15,700	66.3'	13,900	79			35.8'	22,000	43.3'	15,400
78	49.2'	15,900	61.7'	15,200	70.2'	13,400	78			39.0'	21,400	45.9'	15,200
77	53.8'	15,900	64.6'	14,600	73.8'	13,200	77			41.3'	20,900	48.6'	15,200
76	57.7'	15,900	69.2'	14,100	77.1'	12,800	76			43.6'	20,500	50.9'	15,000
75	62.3'	15,900	72.8'	13,700	80.7'	12,600	75	37.1'	31,100	46.3'	20,100	53.2'	14,800
73	69.9'	15,000	80.1'	13,000	87.6'	11,900	73	42.3'	29,100	51.2'	19,200	57.7'	14,300
70	81.4'	13,700	90.9'	11,900	97.1'	11,000	70	49.9'	26,900	58.7'	18,100	64.3'	13,900
68	88.3'	13,000	97.4'	11,500	103.0'	10,600	68	54.8'	25,600	63.3'	17,400	68.9'	13,700
65	98.8'	11,900	107.0'	10,800	113.0'	10,100	65	62.0'	23,800	70.2'	16,800	75.1'	13,400
63	105.0'	11,500	114.0'	10,400	118.0'	9,700	63	66.6'	22,900	74.8'	16,300	79.4'	13,200
60	115.0'	10,600	123.0'	9,700	127.0'	9,300	60	73.5'	21,800	81.4'	15,700	85.3'	13,000
58	121.0'	9,900	129.0'	9,300	133.0'	9,000	58	77.8'	21,200	85.3'	15,200	89.2'	12,800
55	130.0'	9,300	136.0'	8,800	140.0'	8,400	55	84.3'	20,100	91.2'	14,800	94.8'	12,800
53	135.0'	8,800	142.0'	8,400	145.0'	8,200	53	87.9'	19,200	95.1'	14,300	98.1'	12,600
50	143.0'	8,400	149.0'	7,900	152.0'	7,700	50	93.8'	18,300	100.0'	14,100	103.0'	12,600
48	148.0'	7,900	154.0'	7,500	156.0'	7,300	48	97.4'	17,600	104.0'	13,900	106.0'	12,600
45	155.0'	7,300	160.0'	6,800	161.0'	6,800	45	103.0'	17,000	109.0'	13,400	111.0'	12,300
43	159.0'	6,800	164.0'	6,600			43	106.0'	16,500	112.0'	13,400		
40	165.0'	6,400	170.0'	6,000			40	111.0'	15,900	116.0'	13,200		
38	169.0'	5,700	173.0'	5,500			38	115.0'	15,400	119.0'	13,000		
35	174.0'	5,100	177.0'	4,900			35	119.0'	15,000	123.0'	13,000		
33	177.0'	4,600	180.0'	4,400			33	121.0'	14,800	125.0'	12,800		
30	182.0'	4,200	185.0'	4,000			30	125.0'	14,100	128.0'	12,800		
28	185.0'	3,700	187.0'	3,500			28	127.0'	13,700	130.0'	12,800		
25	188.0'	3,300	190.0'	3,300			25	131.0'	13,000	133.0'	12,600		
23	191.0'	3,100					23	132.0'	12,600				
20	193.0'	2,900					20	135.0'	12,100				

C : Loaded boom angle (°)
R : Load radius in feet
W : Rated lifting capacity in pounds

GR-1600XL RATED LIFTING CAPACITIES (IN POUNDS)

59.1' (18.0 m) Manual offset jib

ON OUTRIGGERS FULLY EXTENDED 26' 10-7/8" (8.2m) SPREAD COUNTERWEIGHT 64,600 lbs (29,300 kg) 360° ROTATION													
C	200.1' (61.0m) Boom + 59.1' (18.0m)						C	187.0' (57.0m) Boom + 59.1' (18.0m)					
	0° offset		20° offset		40° offset			0° offset		20° offset		40° offset	
	R	W	R	W	R	W		R	W	R	W	R	W
81.5	49.5'	8,200	73.5'	8,200	89.2'	7,100	81.5	43.6'	8,800	66.3'	8,800	81.4'	7,300
81	52.8'	8,200	75.5'	8,200	92.5'	7,100	81	46.3'	8,800	69.2'	8,800	84.0'	7,300
80	58.1'	8,200	82.0'	8,200	97.1'	6,800	80	51.5'	8,800	74.5'	8,800	88.9'	7,300
79	64.3'	8,200	87.6'	8,200	102.0'	6,800	79	56.8'	8,800	79.4'	8,600	92.9'	7,100
78	70.5'	8,200	92.9'	7,900	107.0'	6,600	78	62.3'	8,800	84.3'	8,400	97.8'	7,100
77	75.5'	8,200	97.8'	7,700	112.0'	6,600	77	67.6'	8,800	88.9'	8,200	102.0'	6,800
76	81.7'	8,200	103.0'	7,500	116.0'	6,600	76	72.8'	8,800	93.8'	8,200	106.0'	6,800
75	87.3'	8,200	107.0'	7,300	120.0'	6,400	75	78.1'	8,800	98.4'	7,900	110.0'	6,800
73	97.4'	8,200	116.0'	6,800	129.0'	6,400	73	88.3'	8,800	107.0'	7,700	118.0'	6,600
70	111.0'	7,500	129.0'	6,400	140.0'	6,000	70	103.0'	8,800	120.0'	7,300	130.0'	6,400
68	120.0'	7,300	137.0'	6,200	148.0'	5,700	68	112.0'	8,400	128.0'	7,100	136.0'	6,200
65	133.0'	6,600	150.0'	5,700	158.0'	5,300	65	124.0'	7,700	139.0'	6,600	147.0'	6,200
63	142.0'	6,400	157.0'	5,500	166.0'	5,300	63	132.0'	7,500	147.0'	6,400	154.0'	6,000
60	154.0'	5,700	168.0'	5,300	175.0'	4,900	60	143.0'	6,800	157.0'	6,200	163.0'	5,700
58	161.0'	5,500	175.0'	4,900	181.0'	4,900	58	151.0'	6,600	164.0'	6,000	169.0'	5,500
55	172.0'	5,100	185.0'	4,600	190.0'	4,400	55	161.0'	6,200	173.0'	5,500	177.0'	5,300
53	178.0'	4,600	190.0'	4,200	194.0'	4,000	53	167.0'	5,700	179.0'	5,300	182.0'	5,100
50	187.0'	4,000	198.0'	3,500	201.0'	3,500	50	176.0'	5,300	187.0'	4,900	189.0'	4,600
48	193.0'	3,500	203.0'	3,300	205.0'	3,300	48	181.0'	4,900	192.0'	4,400	193.0'	4,400
45	201.0'	3,100	210.0'	2,900	211.0'	2,600	45	189.0'	4,400	198.0'	4,000	199.0'	3,700
43	206.0'	2,900	214.0'	2,400			43	194.0'	4,000	203.0'	3,700		
40	213.0'	2,200	220.0'	2,000			40	201.0'	3,500	208.0'	3,100		
38	218.0'	2,000					38	205.0'	3,100	212.0'	2,600		
							35	211.0'	2,600	217.0'	2,200		
							33	215.0'	2,200	219.0'	2,000		
							30	220.0'	1,800				

ON OUTRIGGERS FULLY EXTENDED 26' 10-7/8" (8.2m) SPREAD COUNTERWEIGHT 64,600 lbs (29,300 kg) 360° ROTATION													
C	172.5' (52.6m) Boom + 59.1' (18.0m)						C	114.9' (35.0m) Boom + 59.1' (18.0m)					
	0° offset		20° offset		40° offset			0° offset		20° offset		40° offset	
	R	W	R	W	R	W		R	W	R	W	R	W
81.5	39.4'	10,400	61.4'	9,700	76.1'	7,500	81.5	24.3'	14,100	43.6'	11,900	59.1'	8,200
81	42.0'	10,400	63.7'	9,700	78.1'	7,500	81	26.3'	14,100	45.0'	11,700	60.4'	8,200
80	46.9'	10,400	68.6'	9,500	83.0'	7,500	80	29.5'	14,100	48.2'	11,500	63.3'	7,900
79	52.2'	10,400	72.8'	9,300	86.9'	7,300	79	33.5'	14,100	51.5'	11,200	65.9'	7,900
78	56.8'	10,400	77.1'	9,000	90.9'	7,300	78	36.4'	14,100	54.5'	11,000	68.6'	7,900
77	61.7'	10,400	81.7'	8,800	94.8'	7,300	77	39.7'	14,100	57.4'	10,600	71.2'	7,700
76	65.9'	10,400	86.0'	8,600	98.8'	7,100	76	42.7'	14,100	60.7'	10,400	73.8'	7,700
75	71.2'	10,400	90.2'	8,600	102.0'	7,100	75	45.9'	14,100	63.3'	10,100	76.8'	7,700
73	81.0'	10,400	98.4'	8,200	110.0'	6,800	73	51.8'	14,100	69.6'	9,900	81.7'	7,500
70	94.2'	10,400	111.0'	7,900	120.0'	6,600	70	61.4'	13,900	74.5'	9,300	88.9'	7,300
68	102.0'	9,900	118.0'	7,700	127.0'	6,600	68	66.6'	13,200	83.3'	9,000	93.5'	7,100
65	114.0'	9,300	129.0'	7,300	136.0'	6,400	65	75.1'	12,300	91.2'	8,600	101.0'	7,100
63	121.0'	8,800	136.0'	7,100	143.0'	6,400	63	80.7'	11,700	96.5'	8,400	105.0'	7,100
60	132.0'	8,400	146.0'	6,800	152.0'	6,200	60	88.9'	11,000	104.0'	7,900	112.0'	6,800
58	139.0'	7,900	152.0'	6,800	158.0'	6,200	58	94.2'	10,600	108.0'	7,900	116.0'	6,800
55	149.0'	7,300	162.0'	6,600	166.0'	6,200	55	101.0'	10,100	115.0'	7,500	122.0'	6,800
53	155.0'	7,100	167.0'	6,400	171.0'	6,200	53	106.0'	9,700	120.0'	7,500	125.0'	6,600
50	163.0'	6,400	175.0'	5,700	177.0'	5,500	50	113.0'	9,300	126.0'	7,300	130.0'	6,600
48	169.0'	6,000	179.0'	5,500	181.0'	5,300	48	118.0'	9,000	130.0'	7,300	134.0'	6,600
45	176.0'	5,300	186.0'	4,900	187.0'	4,900	45	124.0'	8,600	135.0'	7,100	138.0'	6,600
43	181.0'	5,100	190.0'	4,600			43	128.0'	8,400	138.0'	7,100		
40	188.0'	4,400	196.0'	4,000			40	134.0'	8,200	143.0'	6,800		
38	192.0'	4,000	199.0'	3,500			38	137.0'	7,900	146.0'	6,800		
35	198.0'	3,500	204.0'	3,100			35	142.0'	7,700	150.0'	6,800		
33	202.0'	3,100	207.0'	2,600			33	145.0'	7,500	153.0'	6,800		
30	208.0'	2,600	211.0'	2,200			30	150.0'	7,300	156.0'	6,800		
28	211.0'	2,400	213.0'	2,000			28	153.0'	7,300	158.0'	6,800		
25	215.0'	2,000	216.0'	1,800			25	156.0'	7,100	160.0'	6,800		
23	218.0'	1,800					23	158.0'	7,100				
							20	161.0'	6,800				

C :Loaded boom angle (°)
R :Load radius in feet
W :Rated lifting capacity in pounds

GR-1600XL RATED LIFTING CAPACITIES (IN POUNDS)

***23.0' (7.0 m) insert + 59.1' (18.0 m) Manual offset jib**

***optional**

ON OUTRIGGERS FULLY EXTENDED 26' 10-7/8" (8.2m) SPREAD COUNTERWEIGHT 64,600 lbs (29,300 kg) 360° ROTATION													
C	200.1' (61.0m) Boom + 23.0' (7.0m) + 59.1' (18.0m)						C	187.0' (57.0m) Boom + 23.0' (7.0m) + 59.1' (18.0m)					
	0° offset		20° offset		40° offset			0° offset		20° offset		40° offset	
	R	W	R	W	R	W		R	W	R	W	R	W
81.5	57.6'	6,800	79.6'	6,400	95.4'	5,700	81.5	51.3'	7,500	73.1'	7,100	88.4'	6,000
81	61.0'	6,800	82.8'	6,400	98.4'	5,700	81	55.0'	7,500	76.2'	7,100	91.4'	6,000
80	67.7'	6,800	89.8'	6,400	105.0'	5,700	80	61.0'	7,500	82.4'	7,100	96.8'	6,000
79	74.2'	6,800	96.0'	6,400	110.0'	5,700	79	66.7'	7,500	88.3'	7,100	102.0'	6,000
78	80.7'	6,800	101.0'	6,200	115.0'	5,500	78	72.9'	7,500	94.3'	7,100	107.0'	6,000
77	87.2'	6,800	107.0'	6,000	120.0'	5,500	77	78.7'	7,500	99.1'	6,800	112.0'	5,700
76	93.1'	6,800	112.0'	5,700	125.0'	5,300	76	84.8'	7,500	104.0'	6,600	117.0'	5,700
75	98.9'	6,600	117.0'	5,500	130.0'	5,100	75	90.0'	7,500	109.0'	6,400	121.0'	5,500
73	109.0'	6,200	127.0'	5,300	138.0'	4,900	73	100.0'	7,100	118.0'	6,000	130.0'	5,500
70	125.0'	5,500	141.0'	4,900	151.0'	4,400	70	115.0'	6,400	132.0'	5,700	143.0'	5,300
68	135.0'	5,300	151.0'	4,600	159.0'	4,200	68	125.0'	6,400	140.0'	5,300	151.0'	5,100
65	149.0'	4,900	163.0'	4,200	171.0'	4,000	65	138.0'	5,700	153.0'	5,100	162.0'	4,900
63	158.0'	4,600	171.0'	4,000	179.0'	3,700	63	146.0'	5,500	161.0'	4,900	169.0'	4,600
60	170.0'	4,200	184.0'	3,700	189.0'	3,500	60	159.0'	5,100	173.0'	4,600	179.0'	4,400
58	179.0'	4,000	192.0'	3,700	196.0'	3,500	58	167.0'	4,900	180.0'	4,400	186.0'	4,200
55	190.0'	3,500	201.0'	3,100	205.0'	3,100	55	178.0'	4,600	190.0'	4,200	194.0'	4,000
53	196.0'	3,100	208.0'	2,900	210.0'	2,600	53	184.0'	4,200	197.0'	4,000	200.0'	3,700
50	206.0'	2,600	216.0'	2,200	219.0'	2,200	50	194.0'	3,700	204.0'	3,300	207.0'	3,300
48	212.0'	2,200	221.0'	1,800	223.0'	1,800	48	200.0'	3,300	209.0'	2,900	211.0'	2,600
							45	208.0'	2,900	216.0'	2,200	218.0'	2,200
							43	213.0'	2,400	221.0'	2,000		
							40	220.0'	1,800				

ON OUTRIGGERS FULLY EXTENDED 26' 10-7/8" (8.2m) SPREAD COUNTERWEIGHT 64,600 lbs (29,300 kg) 360° ROTATION													
C	172.5' (52.6m) Boom + 23.0' (7.0m) + 59.1' (18.0m)						C	114.9' (35.0m) Boom + 23.0' (7.0m) + 59.1' (18.0m)					
	0° offset		20° offset		40° offset			0° offset		20° offset		40° offset	
	R	W	R	W	R	W		R	W	R	W	R	W
81.5	46.2'	8,600	68.4'	7,900	82.4'	6,200	81.5	28.1'	11,900	48.4'	9,900	63.5'	7,300
81	49.2'	8,600	70.9'	7,900	84.8'	6,200	81	29.9'	11,900	50.3'	9,900	65.4'	7,300
80	54.9'	8,600	76.8'	7,900	89.9'	6,200	80	33.9'	11,900	54.2'	9,900	69.0'	7,300
79	60.4'	8,600	81.5'	7,700	94.7'	6,200	79	37.5'	11,900	57.6'	9,700	72.7'	7,300
78	65.9'	8,600	86.2'	7,500	99.4'	6,200	78	41.4'	11,900	61.6'	9,500	75.1'	7,100
77	71.3'	8,600	91.2'	7,300	104.0'	6,000	77	45.0'	11,900	64.4'	9,000	78.2'	6,800
76	76.3'	8,600	95.8'	7,100	108.0'	6,000	76	49.0'	11,900	67.7'	8,800	81.9'	6,800
75	81.8'	8,600	100.0'	6,800	112.0'	5,700	75	52.6'	11,900	71.7'	8,600	84.2'	6,600
73	92.4'	8,600	109.0'	6,600	120.0'	5,500	73	59.9'	11,900	77.6'	7,900	90.6'	6,400
70	106.0'	7,900	122.0'	6,200	132.0'	5,300	70	69.8'	10,800	87.5'	7,500	98.5'	6,000
68	115.0'	7,700	131.0'	6,000	140.0'	5,300	68	76.5'	10,100	93.1'	7,100	104.0'	5,700
65	128.0'	7,100	143.0'	5,700	150.0'	5,100	65	85.8'	9,000	102.0'	6,600	112.0'	5,500
63	136.0'	6,800	151.0'	5,500	157.0'	4,900	63	91.9'	8,600	108.0'	6,400	117.0'	5,300
60	148.0'	6,400	161.0'	5,300	167.0'	4,900	60	101.0'	7,700	116.0'	6,000	124.0'	5,100
58	155.0'	6,000	168.0'	5,100	173.0'	4,600	58	106.0'	7,300	121.0'	5,700	129.0'	5,100
55	166.0'	5,500	178.0'	4,900	183.0'	4,600	55	115.0'	6,800	129.0'	5,500	136.0'	4,900
53	172.0'	5,300	184.0'	4,600	187.0'	4,400	53	120.0'	6,600	134.0'	5,300	140.0'	4,900
50	181.0'	4,600	192.0'	4,200	195.0'	4,200	50	128.0'	6,200	141.0'	5,100	146.0'	4,600
48	187.0'	4,200	198.0'	4,000	199.0'	3,700	48	133.0'	6,000	145.0'	4,900	150.0'	4,600
45	195.0'	3,700	204.0'	3,300	205.0'	3,100	45	140.0'	5,500	152.0'	4,900	154.0'	4,400
43	199.0'	3,300	208.0'	2,900			43	145.0'	5,500	155.0'	4,600		
40	206.0'	2,600	214.0'	2,200			40	151.0'	5,100	161.0'	4,600		
38	211.0'	2,400	218.0'	2,000			38	155.0'	5,100	164.0'	4,400		
35	217.0'	1,800					35	161.0'	4,900	169.0'	4,400		
							33	164.0'	4,600	172.0'	4,400		
							30	169.0'	4,600	175.0'	4,200		
							28	172.0'	4,400	177.0'	4,200		
							25	176.0'	4,400	180.0'	4,200		
							23	179.0'	4,400				

C :Loaded boom angle (°)
R :Load radius in feet
W :Rated lifting capacity in pounds

GR-1600XL RATED LIFTING CAPACITIES (IN POUNDS)

***45.9' (14.0 m) insert + 59.1' (18.0 m) Manual offset jib**

***optional**

ON OUTRIGGERS FULLY EXTENDED 26' 10-7/8" (8.2m) SPREAD						
COUNTERWEIGHT 64,600 lbs (29,300 kg)						
360° ROTATION						
C	200.1' (61.0m) Boom + 45.9' (14.0m) + 59.1' (18.0m)					
	0° offset		20° offset		40° offset	
	R	W	R	W	R	W
81.5	65.0'	4,600	86.6'	4,600	105.0'	4,600
81	68.9'	4,600	90.2'	4,600	109.0'	4,600
80	76.1'	4,600	97.7'	4,600	115.0'	4,600
79	83.3'	4,600	104.0'	4,600	121.0'	4,400
78	90.2'	4,600	111.0'	4,600	127.0'	4,400
77	96.8'	4,600	117.0'	4,400	132.0'	4,200
76	104.0'	4,600	123.0'	4,400	137.0'	4,000
75	110.0'	4,600	129.0'	4,200	142.0'	4,000
73	123.0'	4,400	140.0'	4,000	152.0'	3,500
70	140.0'	4,000	155.0'	3,500	166.0'	3,300
68	150.0'	3,700	165.0'	3,300	175.0'	3,100
65	166.0'	3,300	180.0'	2,900	188.0'	2,900
63	176.0'	3,100	189.0'	2,900	196.0'	2,600
60	190.0'	2,900	202.0'	2,600	208.0'	2,400
58	199.0'	2,600	210.0'	2,400	215.0'	2,200
55	210.0'	2,000	220.0'	1,800	225.0'	1,800

ON OUTRIGGERS FULLY EXTENDED 26' 10-7/8" (8.2m) SPREAD						
COUNTERWEIGHT 64,600 lbs (29,300 kg)						
360° ROTATION						
C	187.0' (57.0m) Boom + 45.9' (14.0m) + 59.1' (18.0m)					
	0° offset		20° offset		40° offset	
	R	W	R	W	R	W
81.5	59.6'	6,200	80.4'	5,300	97.2'	4,900
81	63.3'	6,200	83.8'	5,300	100.0'	4,900
80	70.0'	6,200	90.5'	5,300	107.0'	4,900
79	76.8'	6,200	96.9'	5,300	112.0'	4,900
78	83.5'	6,200	102.0'	5,100	117.0'	4,600
77	89.1'	6,000	108.0'	5,100	122.0'	4,400
76	95.2'	5,700	113.0'	4,900	127.0'	4,400
75	101.0'	5,500	119.0'	4,600	132.0'	4,200
73	112.0'	5,100	129.0'	4,400	142.0'	4,200
70	128.0'	4,600	144.0'	4,200	155.0'	3,700
68	138.0'	4,400	154.0'	4,000	165.0'	3,700
65	153.0'	4,000	168.0'	3,500	177.0'	3,500
63	163.0'	4,000	177.0'	3,500	185.0'	3,300
60	176.0'	3,500	189.0'	3,300	196.0'	3,100
58	184.0'	3,300	197.0'	3,100	203.0'	3,100
55	197.0'	3,100	208.0'	2,900	212.0'	2,600
53	204.0'	2,600	214.0'	2,400	218.0'	2,400
50	214.0'	2,200	223.0'	2,000	226.0'	2,000
48	221.0'	1,800	229.0'	1,800	231.0'	1,800

ON OUTRIGGERS FULLY EXTENDED 26' 10-7/8" (8.2m) SPREAD						
COUNTERWEIGHT 64,600 lbs (29,300 kg)						
360° ROTATION						
C	172.5' (52.6m) Boom + 45.9' (14.0m) + 59.1' (18.0m)					
	0° offset		20° offset		40° offset	
	R	W	R	W	R	W
81.5	53.7'	7,100	73.5'	6,000	90.1'	5,300
81	57.2'	7,100	76.7'	6,000	92.7'	5,300
80	63.6'	7,100	83.1'	6,000	98.8'	5,300
79	69.9'	7,100	88.8'	6,000	104.0'	5,300
78	75.9'	7,100	93.9'	5,700	109.0'	5,100
77	81.7'	6,800	98.9'	5,500	113.0'	4,900
76	87.0'	6,600	104.0'	5,300	119.0'	4,900
75	92.3'	6,400	109.0'	5,300	122.0'	4,600
73	103.0'	6,000	119.0'	4,900	132.0'	4,400
70	118.0'	5,500	133.0'	4,600	145.0'	4,200
68	128.0'	5,100	142.0'	4,400	153.0'	4,000
65	142.0'	4,900	155.0'	4,000	165.0'	3,700
63	150.0'	4,400	163.0'	3,700	172.0'	3,500
60	164.0'	4,200	175.0'	3,500	183.0'	3,300
58	171.0'	4,000	183.0'	3,500	190.0'	3,300
55	184.0'	3,700	194.0'	3,300	200.0'	3,100
53	190.0'	3,500	202.0'	3,300	206.0'	3,100
50	200.0'	2,900	210.0'	2,900	213.0'	2,600
48	207.0'	2,600	215.0'	2,400	218.0'	2,400
45	215.0'	2,200	223.0'	2,200	225.0'	2,000
43	220.0'	2,000	228.0'	2,000		

ON OUTRIGGERS FULLY EXTENDED 26' 10-7/8" (8.2m) SPREAD						
COUNTERWEIGHT 64,600 lbs (29,300 kg)						
360° ROTATION						
C	114.9' (35.0m) Boom + 45.9' (14.0m) + 59.1' (18.0m)					
	0° offset		20° offset		40° offset	
	R	W	R	W	R	W
81.5	34.2'	9,700	53.8'	7,900	69.6'	6,400
81	36.4'	9,700	56.0'	7,900	71.7'	6,400
80	40.9'	9,700	60.4'	7,900	75.4'	6,400
79	45.4'	9,700	64.2'	7,700	79.2'	6,200
78	49.4'	9,700	68.3'	7,500	83.3'	6,200
77	53.7'	9,700	72.1'	7,300	86.4'	6,000
76	57.7'	9,500	76.0'	7,100	89.8'	5,700
75	61.9'	9,000	80.1'	6,800	92.8'	5,500
73	69.2'	8,400	86.7'	6,400	99.7'	5,300
70	80.6'	7,500	97.7'	6,000	109.0'	4,900
68	88.0'	7,100	105.0'	5,500	116.0'	4,600
65	98.6'	6,400	114.0'	5,100	124.0'	4,200
63	106.0'	6,200	120.0'	4,600	129.0'	4,000
60	116.0'	5,500	130.0'	4,400	138.0'	3,700
58	122.0'	5,300	136.0'	4,200	143.0'	3,500
55	131.0'	4,600	144.0'	3,700	151.0'	3,300
53	137.0'	4,400	149.0'	3,500	156.0'	3,300
50	146.0'	4,200	157.0'	3,300	162.0'	3,100
48	151.0'	4,000	163.0'	3,300	167.0'	3,100
45	159.0'	3,500	170.0'	3,100	172.0'	2,900
43	165.0'	3,500	175.0'	3,100		
40	171.0'	3,300	181.0'	2,900		
38	176.0'	3,100	184.0'	2,900		
35	182.0'	2,900	189.0'	2,600		
33	186.0'	2,900	193.0'	2,600		
30	191.0'	2,600	196.0'	2,400		
28	194.0'	2,600	199.0'	2,400		
25	198.0'	2,400	202.0'	2,400		
23	201.0'	2,400				

C :Loaded boom angle (°)
R :Load radius in feet
W :Rated lifting capacity in pounds

GR-1600XL RATED LIFTING CAPACITIES (IN POUNDS)

***33.8' (10.3 m) Hydraulic offset jib**

***optional**

ON OUTRIGGERS FULLY EXTENDED 26' 10-7/8" (8.2m) SPREAD COUNTERWEIGHT 64,600 lbs (29,300 kg) 360° ROTATION													
C	200.1' (61.0m) Boom + 33.8' (10.3m)						C	187.0' (57.0m) Boom + 33.8' (10.3m)					
	5° offset		20° offset		40° offset			5° offset		20° offset		40° offset	
	R	W	R	W	R	W		R	W	R	W	R	W
81.5	48.2'	12,100	57.1'	12,100	66.9'	11,200	81.5	42.3'	13,700	51.5'	13,700	61.4'	12,800
81	51.2'	12,100	61.0'	12,100	69.2'	11,000	81	44.9'	13,700	54.1'	13,700	63.3'	12,600
80	56.4'	12,100	65.3'	11,900	74.1'	10,800	80	49.9'	13,700	58.7'	13,400	67.6'	12,100
79	61.7'	12,100	69.6'	11,500	78.7'	10,400	79	54.8'	13,700	63.3'	13,000	71.9'	11,900
78	67.3'	12,100	74.1'	11,000	82.7'	10,100	78	59.7'	13,700	67.6'	12,600	75.5'	11,500
77	71.9'	11,900	80.1'	10,800	86.9'	9,900	77	64.3'	13,700	71.9'	12,300	79.7'	11,200
76	76.4'	11,500	83.0'	10,400	91.2'	9,700	76	68.2'	13,200	76.1'	11,900	83.3'	10,800
75	80.4'	11,000	87.6'	10,100	94.8'	9,300	75	72.5'	12,800	79.7'	11,500	87.3'	10,600
73	89.6'	10,600	96.1'	9,700	103.0'	8,800	73	80.7'	11,900	87.9'	10,800	94.8'	10,100
70	102.0'	9,500	108.0'	8,800	114.0'	8,400	70	92.5'	11,000	99.4'	10,100	105.0'	9,500
68	110.0'	9,000	116.0'	8,400	121.0'	7,900	68	100.0'	10,400	106.0'	9,500	112.0'	9,000
65	122.0'	8,400	127.0'	7,900	132.0'	7,500	65	111.0'	9,500	117.0'	8,800	122.0'	8,400
63	129.0'	7,900	134.0'	7,500	138.0'	7,300	63	118.0'	9,300	124.0'	8,600	128.0'	8,200
60	139.0'	7,300	144.0'	6,800	148.0'	6,600	60	128.0'	8,600	133.0'	8,200	137.0'	7,700
58	146.0'	6,800	151.0'	6,600	154.0'	6,400	58	135.0'	8,200	139.0'	7,700	143.0'	7,500
55	155.0'	6,200	159.0'	6,000	163.0'	6,000	55	144.0'	7,700	148.0'	7,300	151.0'	7,100
53	161.0'	6,000	165.0'	5,700	168.0'	5,500	53	150.0'	7,300	154.0'	7,100	156.0'	6,800
50	169.0'	5,300	173.0'	5,100	175.0'	4,900	50	158.0'	6,800	161.0'	6,400	164.0'	6,400
48	175.0'	4,900	178.0'	4,600	180.0'	4,600	48	163.0'	6,400	166.0'	6,200	168.0'	6,000
45	182.0'	4,400	185.0'	4,200	186.0'	4,200	45	170.0'	5,700	173.0'	5,500	174.0'	5,500
43	187.0'	4,000	190.0'	4,000			43	174.0'	5,300	177.0'	5,300		
40	193.0'	3,500	195.0'	3,300			40	180.0'	4,900	183.0'	4,600		
38	197.0'	3,100	199.0'	2,900			38	184.0'	4,400	186.0'	4,200		
35	202.0'	2,400	204.0'	2,400			35	190.0'	3,700	191.0'	3,500		
33	206.0'	2,200	207.0'	2,000			33	193.0'	3,500	194.0'	3,300		
30	210.0'	1,800					30	198.0'	2,900	198.0'	2,900		
							28	200.0'	2,600	201.0'	2,600		
							25	204.0'	2,400	203.0'	2,200		
							23	206.0'	2,200				
							20	208.0'	2,000				

ON OUTRIGGERS FULLY EXTENDED 26' 10-7/8" (8.2m) SPREAD COUNTERWEIGHT 64,600 lbs (29,300 kg) 360° ROTATION													
C	172.5' (52.6m) Boom + 33.8' (10.3m)						C	114.9' (35.0m) Boom + 33.8' (10.3m)					
	5° offset		20° offset		40° offset			5° offset		20° offset		40° offset	
	R	W	R	W	R	W		R	W	R	W	R	W
81.5	37.1'	15,900	46.9'	15,900	57.1'	15,000	81.5			29.2'	23,400	37.1'	16,100
81	39.4'	15,900	49.2'	15,900	59.1'	14,800	81			30.5'	23,100	38.4'	15,900
80	44.0'	15,900	53.5'	15,900	63.0'	14,300	80			33.1'	22,500	41.0'	15,700
79	48.6'	15,900	57.7'	15,400	66.6'	13,900	79			35.8'	22,000	43.3'	15,400
78	52.8'	15,900	61.7'	15,000	70.2'	13,400	78			39.0'	21,400	45.9'	15,200
77	57.4'	15,900	65.3'	14,600	73.8'	13,000	77			41.3'	20,900	48.6'	15,200
76	61.7'	15,900	69.2'	14,100	77.4'	12,800	76			43.6'	20,500	50.9'	15,000
75	64.3'	15,200	73.2'	13,700	80.7'	12,300	75	38.7'	28,200	46.3'	20,100	53.1'	14,800
73	72.2'	14,300	80.1'	12,800	87.6'	11,900	73	44.0'	26,900	51.2'	19,200	57.7'	14,300
70	84.3'	13,000	90.6'	11,900	97.1'	11,000	70	51.2'	24,900	58.7'	18,100	64.6'	13,900
68	91.5'	12,300	97.8'	11,500	104.0'	10,600	68	56.4'	23,800	63.3'	17,400	68.9'	13,700
65	102.0'	11,500	107.0'	10,600	113.0'	9,900	65	63.3'	22,300	70.2'	16,800	75.1'	13,400
63	109.0'	11,000	114.0'	10,100	118.0'	9,700	63	67.9'	21,200	74.8'	16,300	79.4'	13,200
60	118.0'	10,100	123.0'	9,700	127.0'	9,300	60	74.8'	19,800	81.4'	15,700	85.3'	13,000
58	124.0'	9,700	129.0'	9,300	133.0'	8,800	58	79.1'	19,200	85.3'	15,200	89.2'	12,800
55	133.0'	9,000	137.0'	8,600	140.0'	8,400	55	85.3'	18,100	91.5'	14,800	94.8'	12,600
53	138.0'	8,600	142.0'	8,400	145.0'	7,900	53	89.2'	17,400	95.1'	14,300	98.1'	12,600
50	146.0'	8,200	149.0'	7,700	151.0'	7,500	50	95.1'	16,800	101.0'	14,100	103.0'	12,600
48	151.0'	7,700	154.0'	7,300	156.0'	7,100	48	99.0'	16,300	104.0'	13,900	106.0'	12,300
45	157.0'	7,100	160.0'	6,600	162.0'	6,600	45	104.0'	15,700	109.0'	13,400	111.0'	12,300
43	162.0'	6,600	164.0'	6,400			43	107.0'	15,400	112.0'	13,400		
40	168.0'	6,000	170.0'	5,700			40	112.0'	15,000	116.0'	13,200		
38	171.0'	5,500	173.0'	5,300			38	115.0'	14,600	119.0'	13,000		
35	176.0'	4,900	178.0'	4,600			35	120.0'	14,300	123.0'	13,000		
33	179.0'	4,400	181.0'	4,200			33	122.0'	14,100	125.0'	12,800		
30	183.0'	3,700	185.0'	3,700			30	126.0'	13,900	129.0'	12,800		
28	186.0'	3,500	187.0'	3,300			28	128.0'	13,200	131.0'	12,800		
25	190.0'	3,100	190.0'	3,100			25	131.0'	12,600	133.0'	12,300		
23	192.0'	2,900					23	133.0'	12,300				
20	194.0'	2,600					20	135.0'	11,900				

C : Loaded boom angle (°)
R : Load radius in feet
W : Rated lifting capacity in pounds

GR-1600XL RATED LIFTING CAPACITIES (IN POUNDS)

***59.1' (18.0 m) Hydraulic offset jib**

***optional**

ON OUTRIGGERS FULLY EXTENDED 26' 10-7/8" (8.2m) SPREAD COUNTERWEIGHT 64,600 lbs (29,300 kg) 360° ROTATION													
C	200.1' (61.0m) Boom + 59.1' (18.0m)						C	187.0' (57.0m) Boom + 59.1' (18.0m)					
	5° offset		20° offset		40° offset			5° offset		20° offset		40° offset	
	R	W	R	W	R	W		R	W	R	W	R	W
81.5	56.1'	8,200	72.2'	8,200	88.9'	7,100	81.5	47.9'	8,800	65.6'	8,800	81.0'	7,300
81	59.1'	8,200	74.5'	8,200	91.9'	7,100	81	49.2'	8,800	68.2'	8,800	83.7'	7,300
80	65.3'	8,200	81.0'	8,200	97.1'	6,800	80	56.4'	8,800	73.8'	8,800	88.6'	7,100
79	70.9'	8,200	86.3'	8,200	102.0'	6,800	79	61.7'	8,800	78.1'	8,600	92.8'	7,100
78	76.8'	8,200	91.5'	7,900	107.0'	6,600	78	66.6'	8,800	83.3'	8,400	97.4'	7,100
77	82.0'	8,200	96.1'	7,700	112.0'	6,600	77	71.9'	8,800	87.6'	8,200	102.0'	6,800
76	87.9'	8,200	101.0'	7,500	116.0'	6,600	76	77.1'	8,800	92.5'	7,900	106.0'	6,800
75	93.5'	8,200	106.0'	7,300	119.0'	6,400	75	82.0'	8,800	97.1'	7,900	110.0'	6,600
73	103.0'	7,700	115.0'	6,800	129.0'	6,200	73	92.2'	8,800	106.0'	7,700	118.0'	6,600
70	117.0'	7,100	128.0'	6,400	140.0'	5,700	70	106.0'	8,200	119.0'	7,300	129.0'	6,400
68	126.0'	6,800	135.0'	6,000	147.0'	5,500	68	114.0'	7,700	127.0'	7,100	137.0'	6,200
65	138.0'	6,200	149.0'	5,700	158.0'	5,300	65	126.0'	7,300	138.0'	6,600	147.0'	6,200
63	147.0'	6,000	156.0'	5,500	165.0'	5,100	63	135.0'	7,100	146.0'	6,400	154.0'	6,000
60	159.0'	5,500	167.0'	5,100	175.0'	4,900	60	146.0'	6,600	156.0'	6,000	163.0'	5,700
58	166.0'	5,100	174.0'	4,900	181.0'	4,600	58	153.0'	6,400	163.0'	5,700	169.0'	5,500
55	176.0'	4,600	183.0'	4,400	189.0'	4,200	55	163.0'	6,000	172.0'	5,500	177.0'	5,300
53	182.0'	4,200	189.0'	4,000	194.0'	3,700	53	169.0'	5,500	177.0'	5,100	182.0'	4,900
50	191.0'	3,700	197.0'	3,500	200.0'	3,300	50	177.0'	4,900	186.0'	4,600	189.0'	4,400
48	197.0'	3,300	201.0'	3,100	205.0'	3,100	48	183.0'	4,600	190.0'	4,200	193.0'	4,200
45	205.0'	2,900	209.0'	2,600	211.0'	2,400	45	191.0'	4,000	198.0'	3,700	199.0'	3,700
43	210.0'	2,600	213.0'	2,400			43	196.0'	3,700	202.0'	3,500		
40	216.0'	2,000	219.0'	1,800			40	202.0'	3,300	207.0'	2,900		
							38	207.0'	2,900	211.0'	2,600		
							35	212.0'	2,200	216.0'	2,000		
							33	216.0'	2,000	219.0'	1,800		

ON OUTRIGGERS FULLY EXTENDED 26' 10-7/8" (8.2m) SPREAD COUNTERWEIGHT 64,600 lbs (29,300 kg) 360° ROTATION													
C	172.5' (52.6m) Boom + 59.1' (18.0m)						C	114.9' (35.0m) Boom + 59.1' (18.0m)					
	5° offset		20° offset		40° offset			5° offset		20° offset		40° offset	
	R	W	R	W	R	W		R	W	R	W	R	W
81.5	44.9'	10,400	61.7'	9,700	76.1'	7,500	81.5	30.2'	14,100	44.6'	11,900	58.7'	8,200
81	47.6'	10,400	64.3'	9,700	78.4'	7,500	81	31.5'	14,100	45.9'	11,700	60.4'	8,200
80	52.8'	10,400	69.2'	9,500	82.7'	7,500	80	35.1'	14,100	49.2'	11,500	63.3'	7,900
79	57.7'	10,400	73.5'	9,300	86.6'	7,300	79	38.4'	14,100	52.5'	11,200	65.9'	7,900
78	63.0'	10,400	78.1'	9,000	90.9'	7,300	78	41.7'	14,100	55.4'	11,000	68.6'	7,900
77	67.3'	10,400	82.0'	8,800	94.8'	7,300	77	44.6'	14,100	58.4'	10,600	71.2'	7,700
76	72.2'	10,400	86.3'	8,600	98.1'	7,100	76	47.9'	14,100	61.0'	10,400	73.8'	7,700
75	76.8'	10,400	90.9'	8,600	102.0'	7,100	75	51.2'	14,100	64.0'	10,100	76.4'	7,700
73	86.6'	10,100	98.8'	8,200	110.0'	6,800	73	57.1'	13,200	70.2'	9,900	81.7'	7,500
70	98.0'	9,500	111.0'	7,700	120.0'	6,600	70	65.9'	12,300	74.8'	9,300	88.9'	7,300
68	114.0'	9,300	118.0'	7,500	127.0'	6,600	68	71.5'	11,700	83.7'	9,000	93.5'	7,100
65	119.0'	8,800	129.0'	7,300	136.0'	6,400	65	80.1'	11,000	91.5'	8,600	100.0'	7,100
63	126.0'	8,400	135.0'	7,100	143.0'	6,400	63	85.3'	10,600	96.5'	8,400	105.0'	7,100
60	136.0'	7,900	146.0'	6,800	152.0'	6,200	60	93.2'	10,100	104.0'	7,900	112.0'	6,800
58	143.0'	7,500	153.0'	6,800	157.0'	6,200	58	98.1'	9,700	109.0'	7,900	116.0'	6,800
55	153.0'	7,100	162.0'	6,600	165.0'	6,200	55	105.0'	9,300	115.0'	7,500	122.0'	6,600
53	159.0'	6,600	167.0'	6,200	170.0'	6,000	53	110.0'	9,000	120.0'	7,500	125.0'	6,600
50	167.0'	6,000	174.0'	5,500	176.0'	5,300	50	117.0'	8,600	126.0'	7,300	130.0'	6,600
48	173.0'	5,500	179.0'	5,300	180.0'	5,100	48	121.0'	8,400	130.0'	7,300	134.0'	6,600
45	180.0'	5,100	186.0'	4,900	186.0'	4,600	45	127.0'	8,200	135.0'	7,100	138.0'	6,600
43	185.0'	4,900	190.0'	4,400			43	131.0'	7,900	138.0'	7,100		
40	191.0'	4,200	195.0'	3,700			40	136.0'	7,700	143.0'	6,800		
38	196.0'	3,700	199.0'	3,300			38	143.0'	7,500	146.0'	6,800		
35	201.0'	3,100	204.0'	2,900			35	145.0'	7,300	150.0'	6,800		
33	205.0'	2,900	207.0'	2,600			33	148.0'	7,300	153.0'	6,800		
30	210.0'	2,400	211.0'	2,200			30	152.0'	7,100	156.0'	6,800		
28	213.0'	2,200	213.0'	2,000			28	155.0'	7,100	158.0'	6,800		
25	217.0'	1,800					25	158.0'	6,800	160.0'	6,800		
							23	160.0'	6,800				
							20	163.0'	6,800				

C :Loaded boom angle (°)
R :Load radius in feet
W :Rated lifting capacity in pounds

GR-1600XL RATED LIFTING CAPACITIES (IN POUNDS)

***23.0' (7.0 m) insert + *59.1' (18.0 m) Hydraulic offset jib**

**optional*

ON OUTRIGGERS FULLY EXTENDED 26' 10-7/8" (8.2m) SPREAD COUNTERWEIGHT 64,600 lbs (29,300 kg) 360° ROTATION													
C	200.1' (61.0m) Boom + 23.0' (7.0m) + 59.1' (18.0m)						C	187.0' (57.0m) Boom + 23.0' (7.0m) + 59.1' (18.0m)					
	5° offset		20° offset		40° offset			5° offset		20° offset		40° offset	
	R	W	R	W	R	W		R	W	R	W	R	W
81.5	63.4'	6,800	79.6'	6,400	95.4'	5,700	81.5	57.5'	7,500	73.1'	7,100	88.4'	6,000
81	66.7'	6,800	82.8'	6,400	98.4'	5,700	81	60.2'	7,500	76.2'	7,100	91.4'	6,000
80	73.3'	6,800	89.8'	6,400	105.0'	5,700	80	66.6'	7,500	82.4'	7,100	96.8'	6,000
79	79.9'	6,800	95.3'	6,200	110.0'	5,700	79	72.9'	7,500	88.3'	7,100	102.0'	6,000
78	86.4'	6,800	101.0'	6,000	115.0'	5,500	78	78.5'	7,500	94.3'	6,800	107.0'	5,700
77	92.1'	6,600	107.0'	6,000	120.0'	5,300	77	84.3'	7,500	99.1'	6,600	112.0'	5,700
76	97.9'	6,400	112.0'	5,700	125.0'	5,100	76	89.8'	7,300	104.0'	6,400	117.0'	5,700
75	103.0'	6,200	117.0'	5,500	130.0'	5,100	75	94.8'	7,100	109.0'	6,200	121.0'	5,500
73	113.0'	5,700	126.0'	5,100	138.0'	4,600	73	105.0'	6,600	118.0'	6,000	130.0'	5,300
70	129.0'	5,300	141.0'	4,600	151.0'	4,400	70	119.0'	6,200	132.0'	5,500	142.0'	5,100
68	138.0'	4,900	150.0'	4,400	159.0'	4,200	68	129.0'	6,000	140.0'	5,300	150.0'	4,900
65	152.0'	4,400	163.0'	4,200	171.0'	4,000	65	142.0'	5,500	153.0'	5,100	161.0'	4,600
63	162.0'	4,200	171.0'	4,000	178.0'	3,700	63	150.0'	5,100	161.0'	4,900	169.0'	4,600
60	174.0'	4,000	184.0'	3,700	189.0'	3,500	60	163.0'	4,900	173.0'	4,400	179.0'	4,200
58	182.0'	3,700	191.0'	3,500	196.0'	3,300	58	171.0'	4,600	180.0'	4,200	186.0'	4,200
55	193.0'	3,300	201.0'	3,100	205.0'	2,900	55	182.0'	4,400	190.0'	4,000	194.0'	4,000
53	200.0'	2,900	207.0'	2,600	210.0'	2,600	53	188.0'	4,000	197.0'	3,700	199.0'	3,500
50	209.0'	2,400	216.0'	2,200	218.0'	2,000	50	197.0'	3,300	204.0'	3,300	206.0'	3,100
48	215.0'	2,000					48	203.0'	3,100	209.0'	2,600	211.0'	2,600
							45	210.0'	2,400	216.0'	2,200	217.0'	2,000
							43	216.0'	2,200	221.0'	1,800		

ON OUTRIGGERS FULLY EXTENDED 26' 10-7/8" (8.2m) SPREAD COUNTERWEIGHT 64,600 lbs (29,300 kg) 360° ROTATION													
C	172.5' (52.6m) Boom + 23.0' (7.0m) + 59.1' (18.0m)						C	114.9' (35.0m) Boom + 23.0' (7.0m) + 59.1' (18.0m)					
	5° offset		20° offset		40° offset			5° offset		20° offset		40° offset	
	R	W	R	W	R	W		R	W	R	W	R	W
81.5	51.9'	8,600	68.4'	7,900	82.4'	6,200	81.5	33.2'	11,900	48.4'	9,900	63.5'	7,300
81	54.9'	8,600	70.9'	7,900	84.8'	6,200	81	35.3'	11,900	50.3'	9,900	65.4'	7,300
80	60.5'	8,600	76.8'	7,900	89.9'	6,200	80	39.3'	11,900	54.2'	9,900	69.0'	7,300
79	66.0'	8,600	81.5'	7,700	94.7'	6,200	79	42.9'	11,900	57.6'	9,700	72.0'	7,100
78	71.5'	8,600	86.2'	7,500	99.4'	6,200	78	46.8'	11,900	61.0'	9,300	75.1'	7,100
77	76.9'	8,600	91.2'	7,300	104.0'	6,000	77	50.4'	11,900	64.4'	9,000	78.2'	6,800
76	82.3'	8,600	95.8'	7,100	108.0'	6,000	76	53.9'	11,700	67.7'	8,800	81.2'	6,600
75	87.0'	8,400	100.0'	6,800	112.0'	5,700	75	57.3'	11,200	71.0'	8,400	84.2'	6,600
73	96.5'	7,900	109.0'	6,600	120.0'	5,500	73	64.3'	10,600	77.6'	7,900	90.0'	6,200
70	110.0'	7,300	122.0'	6,200	132.0'	5,300	70	74.1'	9,500	86.8'	7,300	98.5'	6,000
68	119.0'	7,100	131.0'	6,000	139.0'	5,100	68	80.4'	8,800	93.1'	7,100	104.0'	5,700
65	132.0'	6,600	143.0'	5,500	150.0'	4,900	65	89.9'	8,200	102.0'	6,600	112.0'	5,500
63	139.0'	6,200	150.0'	5,300	157.0'	4,900	63	95.9'	7,700	108.0'	6,200	117.0'	5,300
60	151.0'	6,000	161.0'	5,100	167.0'	4,600	60	105.0'	7,100	116.0'	6,000	124.0'	5,100
58	159.0'	5,700	168.0'	5,100	173.0'	4,600	58	110.0'	6,600	121.0'	5,700	129.0'	4,900
55	169.0'	5,300	178.0'	4,900	182.0'	4,400	55	119.0'	6,200	129.0'	5,300	136.0'	4,900
53	175.0'	4,900	184.0'	4,600	187.0'	4,400	53	124.0'	6,000	134.0'	5,300	140.0'	4,600
50	184.0'	4,400	192.0'	4,000	194.0'	4,000	50	132.0'	5,700	141.0'	5,100	146.0'	4,600
48	190.0'	4,000	197.0'	3,700	199.0'	3,500	48	137.0'	5,500	145.0'	4,900	149.0'	4,400
45	198.0'	3,500	203.0'	3,100	205.0'	2,900	45	144.0'	5,300	151.0'	4,600	154.0'	4,400
43	202.0'	3,100	207.0'	2,600			43	148.0'	5,100	155.0'	4,600		
40	209.0'	2,400	213.0'	2,000			40	154.0'	4,900	161.0'	4,400		
38	213.0'	2,000	217.0'	1,800			38	158.0'	4,600	164.0'	4,400		
							35	164.0'	4,600	169.0'	4,200		
							33	167.0'	4,400	171.0'	4,200		
							30	171.0'	4,400	175.0'	4,200		
							28	174.0'	4,400	177.0'	4,200		
							25	178.0'	4,200	180.0'	4,200		
							23	180.0'	4,200				

C : Loaded boom angle (°)
R : Load radius in feet
W : Rated lifting capacity in pounds

GR-1600XL RATED LIFTING CAPACITIES (IN POUNDS)

***45.9' (14.0 m) insert + *59.1' (18.0 m) Hydraulic offset jib**

*optional

ON OUTRIGGERS FULLY EXTENDED 26' 10-7/8" (8.2m) SPREAD COUNTERWEIGHT 64,600 lbs (29,300 kg) 360° ROTATION													
C	200.1' (61.0m) Boom + 45.9' (14.0m) + 59.1' (18.0m)						C	187.0' (57.0m) Boom + 45.9' (14.0m) + 59.1' (18.0m)					
	5° offset		20° offset		40° offset			5° offset		20° offset		40° offset	
	R	W	R	W	R	W		R	W	R	W	R	W
81.5	70.7'	4,600	86.6'	4,600	105.0'	4,600	81.5	65.2'	6,200	80.4'	5,300	97.2'	4,900
81	74.3'	4,600	90.2'	4,600	109.0'	4,600	81	68.7'	6,200	83.8'	5,300	100.0'	4,900
80	82.1'	4,600	97.7'	4,600	115.0'	4,400	80	75.0'	6,000	90.5'	5,300	107.0'	4,900
79	89.0'	4,600	104.0'	4,600	121.0'	4,400	79	81.7'	6,000	96.9'	5,300	112.0'	4,600
78	97.5'	4,600	111.0'	4,600	126.0'	4,200	78	87.7'	5,700	102.0'	5,100	117.0'	4,600
77	103.0'	4,600	117.0'	4,400	131.0'	4,000	77	93.7'	5,500	108.0'	4,900	122.0'	4,400
76	110.0'	4,600	123.0'	4,200	137.0'	4,000	76	99.2'	5,300	113.0'	4,900	127.0'	4,400
75	116.0'	4,400	128.0'	4,000	142.0'	3,700	75	106.0'	5,300	119.0'	4,600	132.0'	4,200
73	128.0'	4,200	139.0'	3,700	152.0'	3,500	73	116.0'	4,900	129.0'	4,400	141.0'	4,000
70	144.0'	3,700	154.0'	3,300	165.0'	3,100	70	132.0'	4,400	144.0'	4,000	155.0'	3,700
68	155.0'	3,300	165.0'	3,100	174.0'	2,900	68	143.0'	4,200	154.0'	3,700	164.0'	3,500
65	170.0'	3,100	180.0'	2,900	187.0'	2,600	65	157.0'	3,700	168.0'	3,500	177.0'	3,300
63	180.0'	2,900	188.0'	2,600	195.0'	2,400	63	166.0'	3,500	176.0'	3,300	184.0'	3,100
60	194.0'	2,600	201.0'	2,400	208.0'	2,400	60	180.0'	3,300	189.0'	3,100	196.0'	3,100
58	202.0'	2,200	209.0'	2,200	214.0'	2,000	58	188.0'	3,100	196.0'	2,900	203.0'	2,900
55	213.0'	1,800					55	199.0'	2,600	207.0'	2,600	212.0'	2,400
							53	207.0'	2,400	213.0'	2,200	217.0'	2,200
							50	216.0'	1,800	223.0'	1,800	226.0'	1,800

ON OUTRIGGERS FULLY EXTENDED 26' 10-7/8" (8.2m) SPREAD COUNTERWEIGHT 64,600 lbs (29,300 kg) 360° ROTATION													
C	172.5' (52.6m) Boom + 45.9' (14.0m) + 59.1' (18.0m)						C	114.9' (35.0m) Boom + 45.9' (14.0m) + 59.1' (18.0m)					
	5° offset		20° offset		40° offset			5° offset		20° offset		40° offset	
	R	W	R	W	R	W		R	W	R	W	R	W
81.5	59.0'	7,100	73.5'	6,000	90.1'	5,300	81.5	39.4'	9,700	53.8'	7,900	69.6'	6,400
81	62.3'	7,100	76.7'	6,000	92.7'	5,300	81	42.0'	9,700	56.0'	7,900	71.7'	6,400
80	68.3'	6,800	83.1'	6,000	98.8'	5,300	80	46.1'	9,700	60.4'	7,900	75.4'	6,400
79	74.1'	6,600	88.2'	5,700	103.0'	5,100	79	50.4'	9,500	64.2'	7,700	79.2'	6,200
78	79.4'	6,400	93.3'	5,500	109.0'	5,100	78	54.4'	9,300	68.3'	7,500	82.7'	6,000
77	85.8'	6,400	98.9'	5,500	113.0'	4,900	77	58.3'	8,800	72.1'	7,300	85.7'	5,700
76	91.0'	6,200	104.0'	5,300	118.0'	4,600	76	62.5'	8,600	75.4'	6,800	89.1'	5,500
75	96.3'	6,000	109.0'	5,100	122.0'	4,600	75	66.0'	8,200	79.4'	6,600	92.8'	5,500
73	107.0'	5,500	119.0'	4,900	132.0'	4,400	73	74.0'	7,700	86.7'	6,400	99.0'	5,100
70	122.0'	5,100	132.0'	4,400	144.0'	4,000	70	84.9'	6,800	97.0'	5,700	109.0'	4,600
68	132.0'	4,900	142.0'	4,200	153.0'	4,000	68	92.3'	6,400	104.0'	5,300	115.0'	4,400
65	145.0'	4,400	155.0'	4,000	165.0'	3,700	65	103.0'	6,000	114.0'	4,900	124.0'	4,200
63	154.0'	4,200	163.0'	3,700	172.0'	3,500	63	109.0'	5,500	120.0'	4,600	129.0'	4,000
60	167.0'	4,000	175.0'	3,500	183.0'	3,300	60	119.0'	5,100	129.0'	4,200	138.0'	3,700
58	175.0'	3,700	183.0'	3,300	190.0'	3,100	58	126.0'	4,600	135.0'	4,000	143.0'	3,500
55	187.0'	3,500	194.0'	3,300	200.0'	3,100	55	135.0'	4,200	144.0'	3,700	151.0'	3,300
53	193.0'	3,100	201.0'	3,100	205.0'	2,900	53	141.0'	4,000	149.0'	3,500	155.0'	3,100
50	202.0'	2,600	210.0'	2,600	213.0'	2,400	50	149.0'	3,700	157.0'	3,300	162.0'	3,100
48	209.0'	2,400	215.0'	2,200	218.0'	2,200	48	155.0'	3,500	162.0'	3,100	166.0'	2,900
45	217.0'	2,000	223.0'	2,000	225.0'	2,000	45	162.0'	3,300	169.0'	2,900	172.0'	2,900
43	223.0'	1,800					43	167.0'	3,100	174.0'	2,900		
							40	174.0'	3,100	180.0'	2,600		
							38	178.0'	2,900	184.0'	2,600		
							35	184.0'	2,600	189.0'	2,600		
							33	188.0'	2,600	192.0'	2,400		
							30	193.0'	2,400	196.0'	2,400		
							28	196.0'	2,400	199.0'	2,400		
							25	200.0'	2,400	202.0'	2,200		
							23	202.0'	2,200				

C : Loaded boom angle (°)
R : Load radius in feet
W : Rated lifting capacity in pounds

GR-1600XL RATED LIFTING CAPACITIES (IN POUNDS)

***11.8' (3.6 m) Heavy duty short jib**

***optional**

ON OUTRIGGERS FULLY EXTENDED 26' 10-7/8" (8.2m) SPREAD COUNTERWEIGHT 64,600 lbs (29,300 kg) 360° ROTATION									
C	200.1' (61.0m) Boom + 11.8' (3.6m)				C	187.0' (57.0m) Boom + 11.8' (3.6m)			
	20° offset		40° offset			20° offset		40° offset	
	R	W	R	W		R	W	R	W
81.5	46.3'	20,700	51.2'	20,300	81.5	41.7'	23,800	44.6'	23,100
81	48.6'	20,300	53.1'	20,100	81	43.6'	23,600	46.6'	22,700
80	52.8'	19,800	57.4'	19,400	80	47.6'	22,700	50.5'	22,000
79	57.1'	19,200	61.4'	18,700	79	50.9'	22,000	53.8'	21,200
78	60.7'	18,500	65.0'	18,100	78	54.5'	21,200	57.7'	20,500
77	64.6'	17,900	68.6'	17,400	77	58.4'	20,500	61.0'	19,800
76	68.6'	17,200	72.5'	17,000	76	61.7'	19,800	64.3'	19,200
75	72.2'	16,500	76.1'	16,300	75	65.3'	19,200	67.9'	18,500
73	79.7'	15,400	83.0'	15,200	73	72.2'	17,900	74.5'	17,400
70	89.9'	13,900	93.5'	13,700	70	82.0'	16,300	84.3'	16,100
68	96.8'	13,000	99.7'	12,800	68	88.3'	15,200	90.6'	15,000
65	107.0'	11,700	110.0'	11,700	65	97.8'	13,900	99.4'	13,700
63	113.0'	11,000	115.0'	10,800	63	104.0'	13,200	106.0'	13,000
60	122.0'	9,900	124.0'	9,900	60	112.0'	11,900	114.0'	11,900
58	128.0'	9,500	130.0'	9,300	58	118.0'	11,200	119.0'	11,200
55	136.0'	8,600	138.0'	8,600	55	126.0'	10,400	127.0'	10,400
53	142.0'	8,200	143.0'	7,700	53	131.0'	9,900	132.0'	9,900
50	149.0'	6,800	149.0'	6,400	50	138.0'	8,800	138.0'	8,600
48	153.0'	6,000	154.0'	5,700	48	142.0'	7,900	142.0'	7,700
45	160.0'	5,100	160.0'	4,900	45	148.0'	6,800	148.0'	6,600
43	164.0'	4,400	164.0'	4,200	43	152.0'	6,200	152.0'	6,000
40	170.0'	3,700	170.0'	3,500	40	158.0'	5,300	158.0'	5,100
38	173.0'	3,300			38	161.0'	4,900		
35	178.0'	2,600			35	166.0'	4,200		
33	181.0'	2,200			33	169.0'	3,700		
30	186.0'	1,800			30	173.0'	3,300		
					28	176.0'	3,100		
					25	179.0'	2,600		
					20	184.0'	2,200		

ON OUTRIGGERS FULLY EXTENDED 26' 10-7/8" (8.2m) SPREAD COUNTERWEIGHT 64,600 lbs (29,300 kg) 360° ROTATION									
C	172.5' (52.6m) Boom + 11.8' (3.6m)				C	114.9' (35.0m) Boom + 11.8' (3.6m)			
	20° offset		40° offset			20° offset		40° offset	
	R	W	R	W		R	W	R	W
81.5	36.7'	28,900	39.7'	27,800	81.5	21.3'	48,900	22.6'	39,700
81	38.7'	28,400	41.7'	27,300	81	22.3'	48,500	23.6'	39,500
80	42.3'	27,300	45.3'	26,200	80	24.6'	47,800	25.9'	39,000
79	45.6'	26,500	48.6'	25,400	79	26.9'	47,000	28.2'	38,600
78	49.2'	25,600	51.8'	24,500	78	29.2'	46,300	30.2'	38,400
77	52.5'	24,700	55.1'	23,800	77	31.2'	45,600	32.5'	37,900
76	55.8'	23,600	58.4'	22,900	76	33.5'	45,000	34.4'	37,700
75	59.1'	22,700	61.4'	22,000	75	35.4'	44,300	36.7'	37,300
73	65.3'	21,200	67.6'	20,500	73	39.7'	43,200	41.0'	36,800
70	74.5'	19,000	76.4'	18,500	70	45.9'	41,700	46.9'	35,900
68	80.1'	17,600	81.4'	17,400	68	50.2'	40,800	51.2'	35,700
65	88.6'	16,100	90.6'	15,900	65	56.1'	39,700	57.1'	35,100
63	94.2'	15,200	95.8'	15,000	63	60.0'	39,000	61.0'	34,800
60	102.0'	13,900	104.0'	13,900	60	65.3'	37,300	66.3'	34,400
58	107.0'	13,200	109.0'	13,000	58	68.9'	35,900	69.9'	34,200
55	115.0'	12,300	116.0'	12,100	55	73.8'	33,500	75.1'	32,800
53	120.0'	11,700	120.0'	11,500	53	77.1'	31,100	78.1'	30,400
50	126.0'	10,400	127.0'	10,100	50	81.7'	27,800	82.3'	27,600
48	130.0'	9,500	131.0'	9,300	48	84.6'	26,000	85.3'	25,800
45	136.0'	8,400	136.0'	7,900	45	88.9'	23,800	89.2'	23,600
43	140.0'	7,500	140.0'	7,300	43	91.5'	22,500	91.9'	22,300
40	145.0'	6,600	145.0'	6,400	40	95.1'	20,700	95.8'	20,500
38	148.0'	6,000			38	97.8'	19,600		
35	153.0'	5,300			35	101.0'	18,300		
33	156.0'	4,900			33	103.0'	17,600		
30	160.0'	4,200			30	106.0'	16,800		
28	162.0'	4,000			28	108.0'	16,100		
25	165.0'	3,500			25	110.0'	15,400		
20	170.0'	3,100			20	114.0'	14,300		

C : Loaded boom angle (°)
R : Load radius in feet
W : Rated lifting capacity in pounds

WARNING AND OPERATING INSTRUCTIONS FOR LIFTING CAPACITIES

GENERAL

1. RATED LIFTING CAPACITIES apply only to the machine as originally manufactured and normally equipped by TADANO LTD. Modifications to the machine or use of optional equipment other than that specified can result in a reduction of capacity.
2. Hydraulic cranes can be hazardous if improperly operated or maintained. Operation and maintenance of this machine must be in compliance with information in the **Operation and Maintenance Manuals** supplied with the crane. If this manual is missing, order a replacement through the distributor.
3. The operator and other personnel associated with this machine shall fully acquaint themselves with the latest applicable ASME B30.5 safety standards for cranes as mentioned in OSHA CFR29 part 1926.

SET UP

1. Rated lifting capacities on the load chart are the maximum allowable crane capacities. They are based on the machine standing level on firm supporting surface under ideal job conditions. Depending on the nature of the supporting surface, it may be necessary to have structural supports under the outrigger floats or tires to spread the loads to a larger surface.
2. For outrigger operation, outriggers shall be properly extended with tires free of supporting surface before operating crane.

OPERATION

1. Rated lifting capacities have been tested to and meet minimum requirements of SAE J1063-Cantilevered Boom Crane Structures Method of Test.
2. Rated lifting capacities do not exceed 85 % of the tipping load on outriggers fully extended as determined by SAE J765-Crane Stability Test Code.
Rated lifting capacities for partially extended outriggers are determined from the formula, Rated Lifting Capacities = (Tipping Load - 0.1 x Tip Reaction) / 1.25.
3. Rated lifting capacities above bold lines in the chart are based on crane strength and those below, on its stability. They are based on actual load radius increased by boom deflection.
4. The weight of handling device such as hook blocks, slings, etc., must be considered as part of the load and must be deducted from the lifting capacities.
5. Rated lifting capacities are based on freely suspended loads and make no allowance for such factors as the effect of wind, sudden stopping of loads, supporting surface conditions, inflation of tires, operating speeds, side loads, etc. Side pull on the boom or jib is extremely dangerous. Such action can damage the boom, jib or slewing mechanism, and lead to overturning the crane.
6. Rated lifting capacities do not account for wind on lifted load or boom. We recommend against working under the condition that the load is out of control due to a strong wind. During boom lift, consider that the rated lifting capacity is reduced by 50% when the wind speed is 20mph(9m/s) to 27mph(12m/s); reduced by 70% when the wind speed is 27mph(12m/s) to 31mph(14m/s). If the wind speed is 31mph(14m/s) or over, stop operation. During jib lift, stop operation if the wind speed is 20mph(9m/s).
7. Rated lifting capacities at load radius shall not be exceeded. Do not tip the crane to determine allowable loads.
8. Do not operate at boom lengths, radii, or boom angle, where no capacities are shown. Crane may overturn without any load on the hook.
9. When boom length is between values listed, refer to the rated lifting capacities of the next longer and next shorter booms for the same radius. The lesser of the two rated lifting capacities shall be used.
10. When making lifts at a load radius not shown, use the next longer radius to determine allowable capacity.

11. Load per line should not exceed 15,900 lbs. (7,200kg) for main hoist and auxiliary hoist.
12. Check the actual number of parts of line with LOAD MOMENT INDICATOR (AML-C) before operation. Maximum lifting capacity is restricted by the number of parts of line of LOAD MOMENT INDICATOR (AML-C). Limited capacity is as determined from the formula, Single line pull for main hoist 15,900 lbs. (7,200kg) x number of parts of line.
13. The boom angle before loading should be greater to account for deflection. For rated lifting capacities, the loaded boom angle and the load radius is for reference only.
14. Do not operate extension or retraction of the boom with loads. Extension or retraction of the boom with loads may be attempted within the limits of the RATED LIFTING CAPACITIES. The ability to telescope loads is limited by hydraulic pressure, boom angle, boom length, crane maintenance, etc.
15. For lifting capacity of single top, deduct the weight of the load handling equipment from the rated lifting capacity of the boom. For the lifting capacity of single top, the net capacity shall not exceed 15,900lbs (7,200kg) including main boom hook mass attached to the boom.
16. When the base jib or top jib or both jibs are removed, set the jib state switch to the REMOVED position.
17. When erecting and stowing jib, be sure to retain it by hand or by other means to prevent its free movement.
18. Use "ANTI-TWO BLOCK" disable switch when erecting and stowing jib and when stowing hook block. While the switch is pushed, the hoist does not stop, even when overwind condition occurs.
19. When lifting a load by using jib (aux. hoist) and boom (main hoist) simultaneously, do the following:
 - Enter the operation status as jib operation, not as boom operation.
 - Before starting operation, make sure that mass of load is within rated lifting capacity for jib.

DEFINITIONS

1. Load Radius: Horizontal distance from a projection of the axis of rotation to supporting surface before loading to the center of the vertical hoist line or tackle with load applied.
2. Loaded Boom Angle: The angle between the boom base section and the horizontal, after lifting the rated lifting capacity at the load radius.
3. Working Area: Area measured in a circular arc about the centerline of rotation.
4. Freely Suspended Load: Load hanging free with no direct external force applied except by the hoist line.
5. Side Load: Horizontal side force applied to the lifted load either on the ground or in the air.

GR-1600XL RATED LIFTING CAPACITIES (IN POUNDS)

ON RUBBER												
Without counterweight												
A	Stationary											
	Over Front and Rear						360° Rotation					
	42.8'		57.2'		71.6'		42.8'		57.2'		71.6'	
B	C	(13.1m)	C	(17.4m)	C	(21.8m)	C	(13.1m)	C	(17.4m)	C	(21.8m)
8'	73	22,000	78	22,000	81	22,000	73	22,000	78	22,000	81	22,000
10'	70	22,000	76	22,000	79	22,000	70	22,000	76	22,000	79	22,000
12'	67	22,000	73	22,000	77	22,000	67	20,500	73	22,000	77	22,000
15'	63	22,000	70	22,000	75	22,000	63	13,700	70	17,400	75	19,400
20'	54	14,800	65	18,100	71	19,600	54	6,200	65	9,900	71	12,100
25'	45	9,000	59	12,300	66	14,100			59	4,900	66	7,100
30'	33	3,500	53	7,700	62	9,700					62	3,300
35'			45	4,000	57	6,000						
D	0		45		57		54		59		62	
Telescoping conditions (%)												
2nd boom	0		0		0		0		0		0	
3rd boom	0		0		0		0		0		0	
4th boom	0		0		0		0		0		0	
5th boom	0		0		0		0		0		0	
Top boom	0		45		90		0		45		90	

- A :Boom length in feet
- B :Load radius in feet
- C :Loaded boom angle (°)
- D :Minimum boom angle (°) for indicated length (no load)

NOTE: The lifting capacity data stored in the LOAD MOMENT INDICATOR (AML-C) is based on the standard number of parts of line listed in the chart. Standard number of parts of line for rubber operation should be according to the following table.

Boom length in feet (meters)	42.8' (13.1m)	42.8' to 71.6' (13.1m to 21.8m)
Number of parts of line	4	4

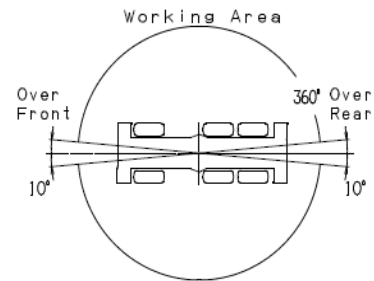

WARNING AND OPERATING INSTRUCTIONS FOR ON RUBBER LIFTING CAPACITIES

- Rated lifting capacities on rubber are in pounds and do not exceed 75 % of tipping loads as determined by SAE J765-Crane Stability Test Code.
- On rubber lifting is only permitted without counterweight and stationary. Creep operation is prohibited.
- Rated lifting capacities shown in the chart are based on condition that crane is set on firm level surfaces with suspension fully-retracted. Those above bold lines are based on tire capacity and those below, on crane stability. They are based on actual load radius increased by tire deformation and boom deflection.
- If the suspension cylinders contain air, the axle will not be locked completely and rated lifting capacities may not be obtainable. Bleed the cylinders according to the operation safety and maintenance manual.
- Rated lifting capacities are based on proper tire inflation, capacity and condition. Damaged tires are hazardous to safe operation of crane.

- Tires shall be inflated to correct air pressure.

Tires	Air Pressure
26.5R25	94 psi (650kPa)

- Over front and rear operation shall be performed within 10 degrees in front/rear of chassis.
- On rubber lifting with "jib" is not permitted. Maximum permissible boom length is 71.6'. (21.8m).
- When making lift on rubber stationary, set parking brake.

GR-1600XL Axle weight distribution chart

0°, 20° or 40° pinned offsets fly jib	Pounds				Kilograms			
	Total	Axle 1	Axle 2	Axle 3	Total	Axle 1	Axle 2	Axle 3
Base machine incl. standard fly jib and auxiliary winch	133,259	78,825	26,693	27,743	60,445	35,754	12,108	12,584
Remove: 7.9 ton (7.2 metric ton) hook ball	-661	-928	134	134	-300	-421	61	61
Auxiliary winch & wire rope	-2,650	1,080	-1,865	-1,865	-1,202	490	-846	-846
Front and rear outrigger boxes and beams	-19,758	-7,635	-6,063	-6,063	-8,962	-3,463	-2,750	-2,750
2 section manual offset fly jib	-3,197	-5,073	939	939	-1,450	-2,301	426	426
Boom	-34,445	-43,094	4,325	4,325	-15,624	-19,547	1,962	1,962
Add: Counterweight 24,500 lbs (11,100 kg)	24,515	-7,388	15,953	15,953	11,120	-3,351	7,236	7,236
Counterweight 40,100 lbs (18,200 kg)	40,036	-12,066	26,050	26,050	18,160	-5,473	11,816	11,816
110 ton (100 metric ton) hook block	2,381	3,904	-763	-763	1,080	1,771	-346	-346

5° - 40° hydraulic offset - Optional	Pounds				Kilograms			
	Total	Axle 1	Axle 2	Axle 3	Total	Axle 1	Axle 2	Axle 3
Base machine incl. standard fly jib and auxiliary winch	134,028	80,361	26,310	27,359	60,794	36,451	11,934	12,410
Remove: 7.9 ton (7.2 metric ton) hook ball	-661	-928	134	134	-300	-421	61	61
Auxiliary winch & wire rope	-2,650	1,080	-1,865	-1,865	-1,202	490	-846	-846
Front and rear outrigger boxes and beams	-19,758	-7,635	-6,063	-6,063	-8,962	-3,463	-2,750	-2,750
2 section hydraulic offset fly jib	-3,417	-5,585	1,085	1,085	-1,550	-2,533	492	492
Boom	-34,996	-44,183	4,592	4,592	-15,874	-20,041	2,083	2,083
Add: Counterweight 24,500 lbs (11,100 kg)	24,515	-7,388	15,953	15,953	11,120	-3,351	7,236	7,236
Counterweight 40,100 lbs (18,200 kg)	40,036	-12,066	26,050	26,050	18,160	-5,473	11,816	11,816
110 ton (100 metric ton) hook block	2,381	3,904	-763	-763	1,080	1,771	-346	-346

TADANO AMERICA Corporation

4242 West Greens Road

Houston, TX 77066 U.S.A.

Phone: 281-869-0030

Fax: 281-869-0040

www.tadanoamerica.com

Form No. TAC-GR-1600-3-04012016